

Università Degli Studi di Ferrara

Dottorato di ricerca in
Fisica
ciclo XXI

Internal polarized gas targets:
systematic studies on intensity
and correlated effects

Settore scientifico disciplinare FIS/01

24/03/2009

Luca Barion

FAIR in 2015(?)



24/03/2009

Luca Barion - Esame dottorato

PAX experiment

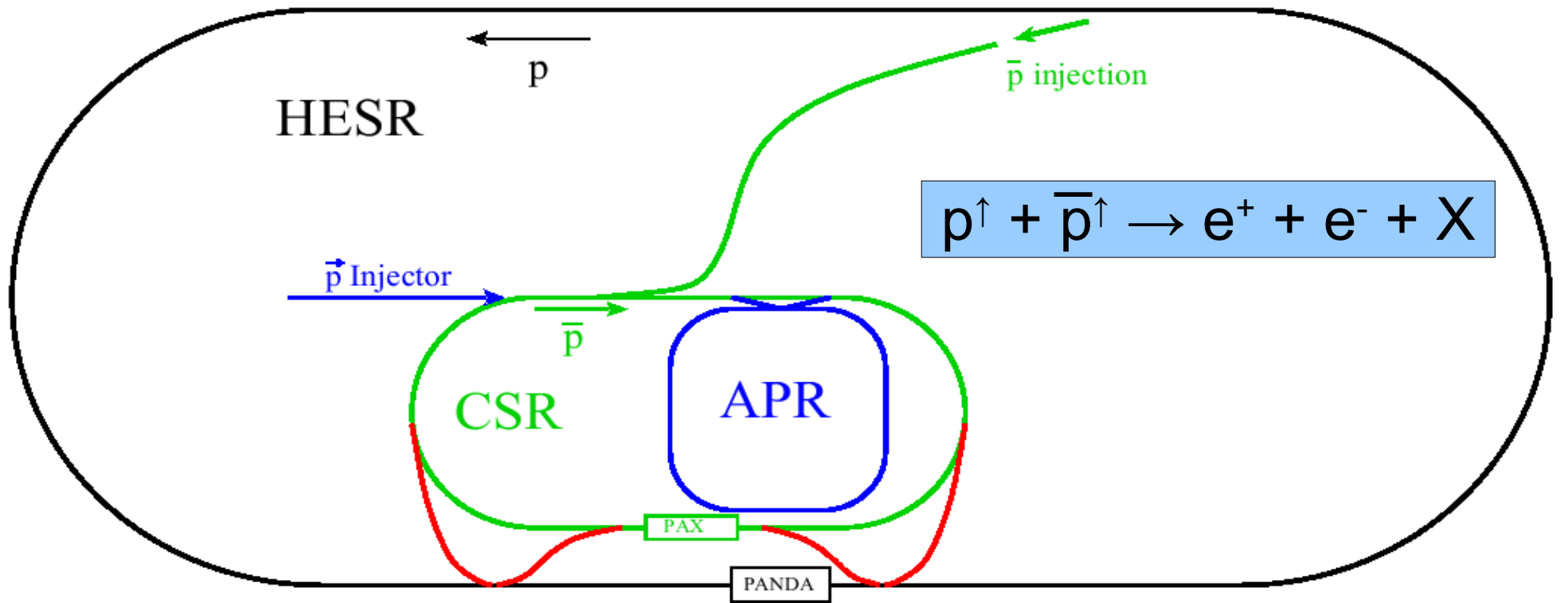

FAIR @ GSI, Darmstadt

Drell-Yan to measure
transversity of nucleons

Requirements:

- stored intense p polarized beam in HESR (15 GeV/c)
- stored intense \bar{p} polarized beam in CSR (3.5 GeV/c)

Antiproton polarization

- ABS -> not possible
- Stern-Gerlach -> never tried
- Channeling -> never tested

Spin filtering Tested in FILTEX in 1992 (p)

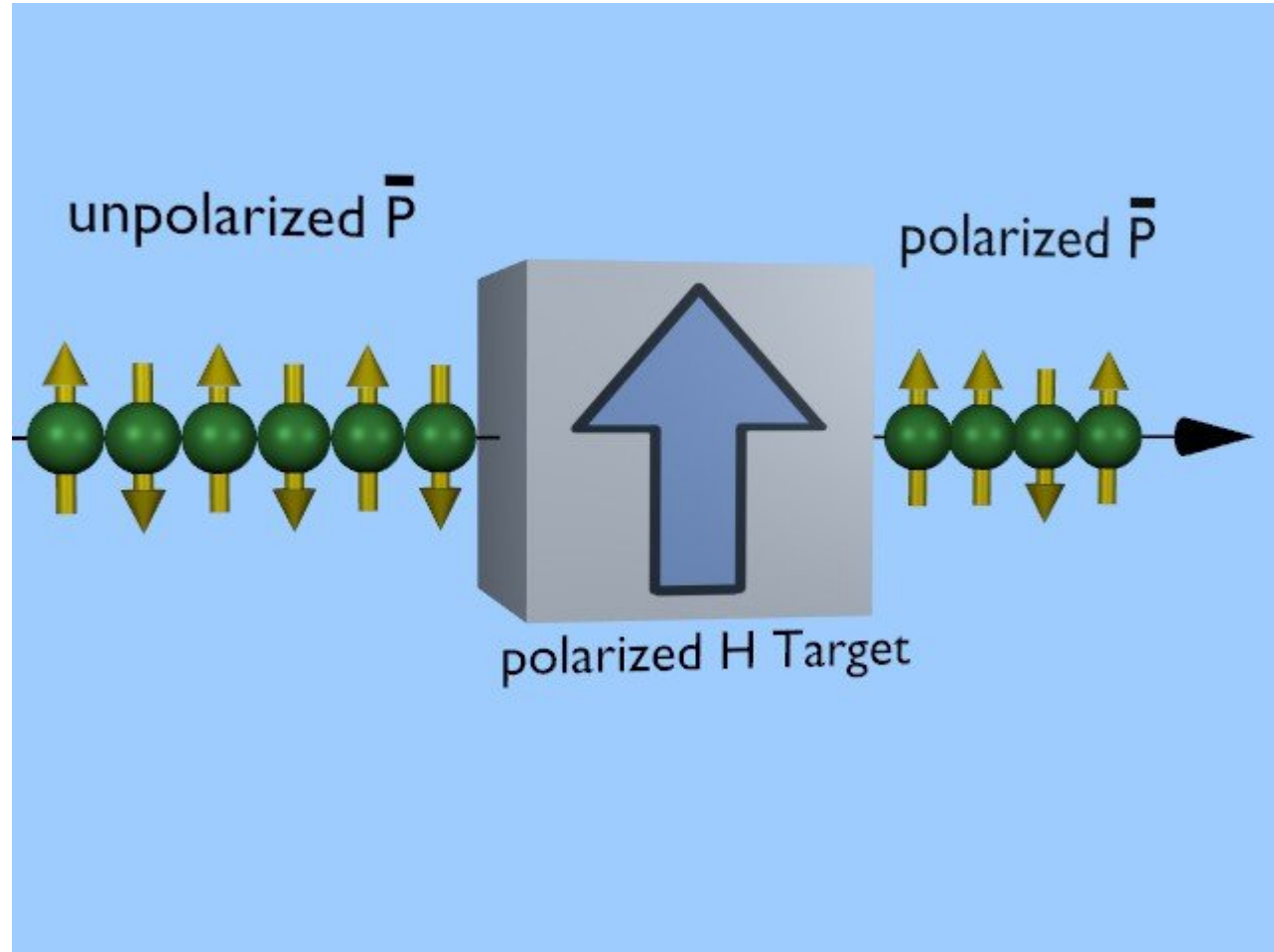
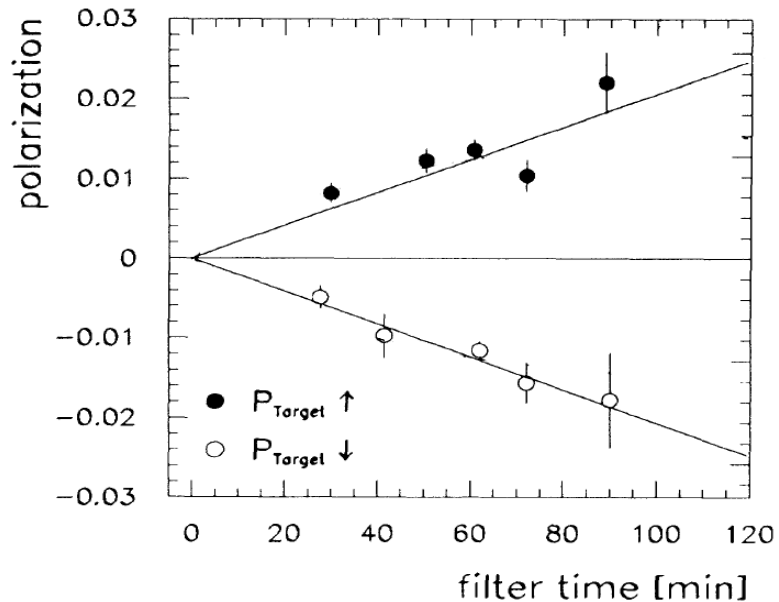

Figure Of Merit (for polarization)

$$\text{FOM}(t) = P(T)^2 \cdot I(T)$$

P antiproton beam polarization

I antiproton beam intensity

T time

Optimum filtering time:

$$T_0 = 2 \tau_B \quad (\tau_B \text{ beam lifetime, time to reduce beam intensity to } I_0/e)$$

Beam lifetime depends on target thickness

(present target thickness $t=10^{14}$ at/cm²)

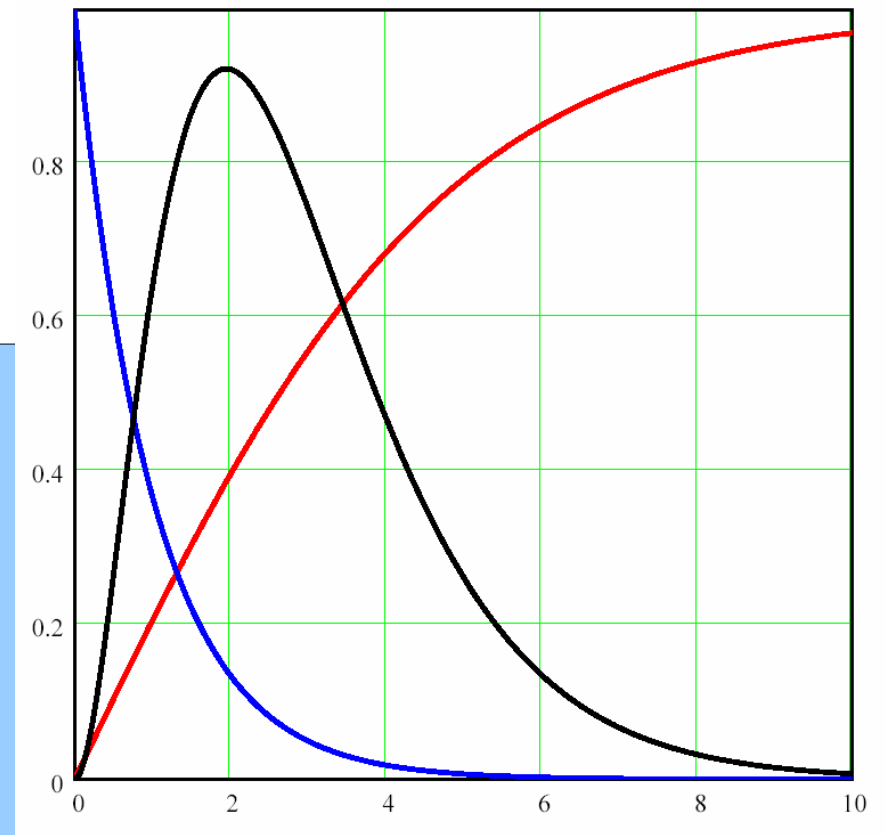

$$T \propto \frac{1}{t}$$

→ Increase in target density is desirable
(to decrease filtering time)

Polarized gas target

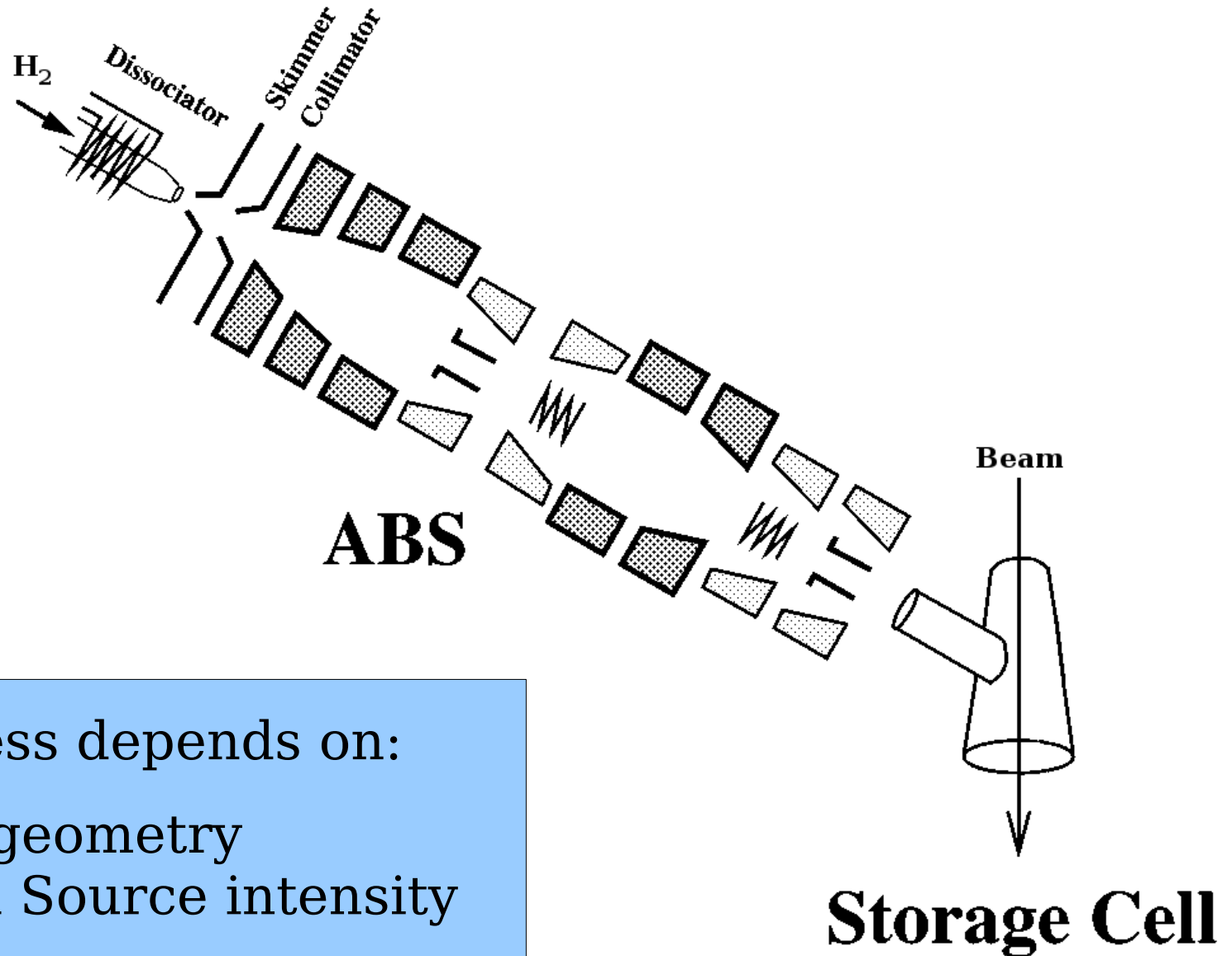

Target thickness depends on:

- Storage cell geometry
- Atomic Beam Source intensity

Spin Lab

ABS1
(CERN)

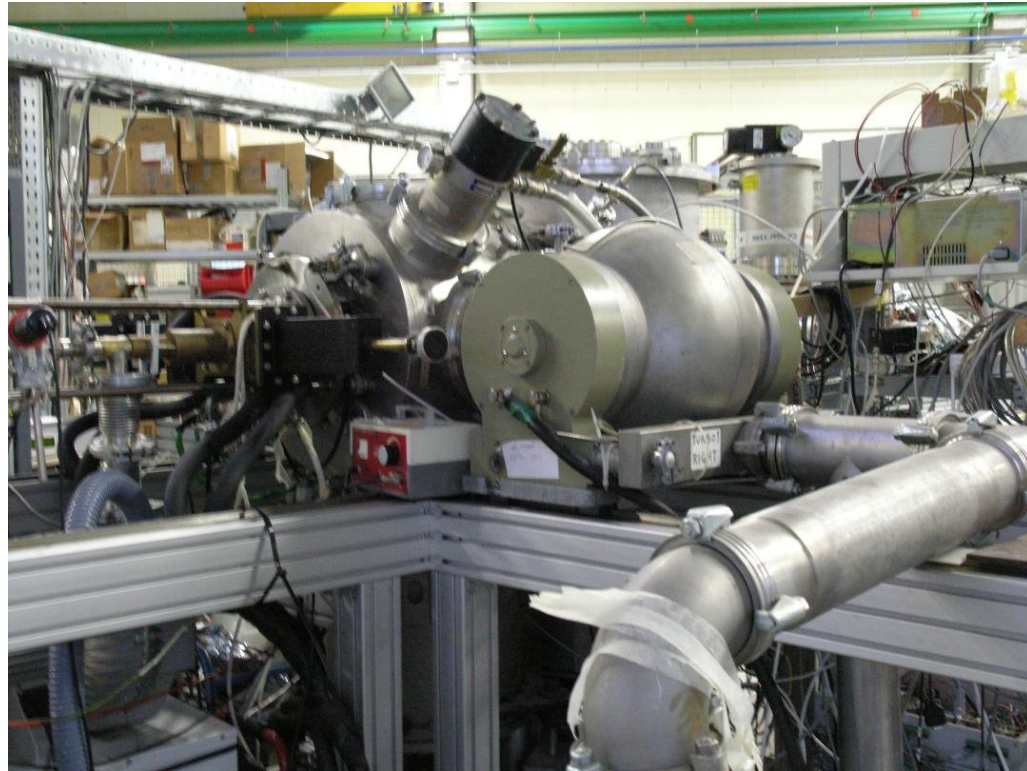

ABS2
(Wisconsin)

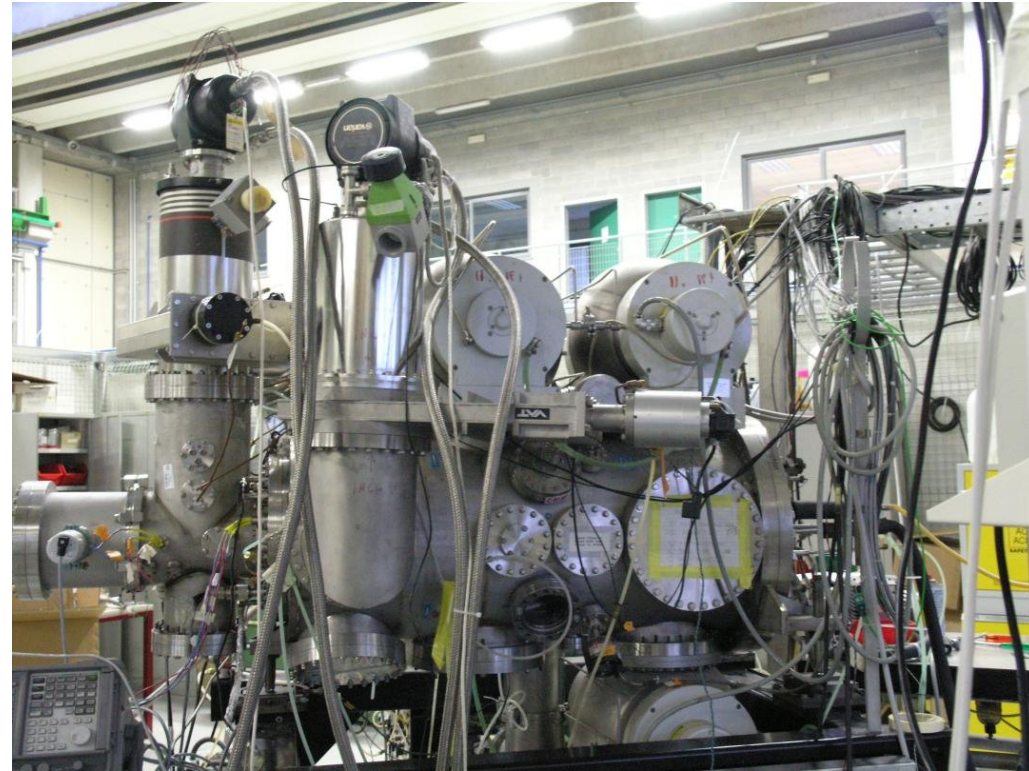

ABS intensity

Modification to storage cell

Effects of modified storage cell

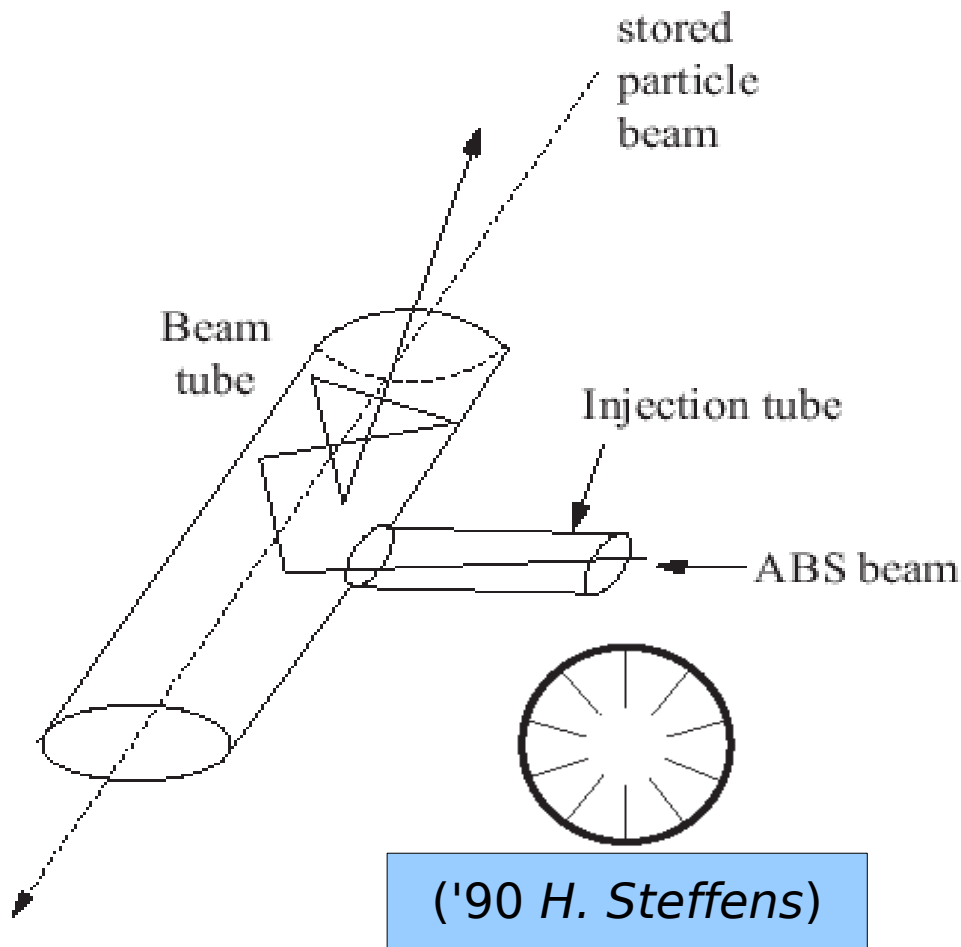

Thickness of gaseous target:

$$t = \frac{I L}{C_{tot}} \left[\frac{at}{cm^2} \right]$$

$$C_{tot} = \gamma C_{beam} + C_{inj} \quad [cm^3/s]$$

I intensity of beam to the cell [at/s]

L beam tube half length

M molec/at gas mass

W. Haeberli, E. Steffens, Rep. Prog. Phys. 66 p 1887 (2003)

$$C = \frac{8}{3\sqrt{\pi}} \left(2k_B \frac{T}{M} \right)^{1/2} \left(\frac{A^2}{sL} \right)$$

Vacuum Technology - Roth A (1990)

Finned injection tube (mounted on test stand)

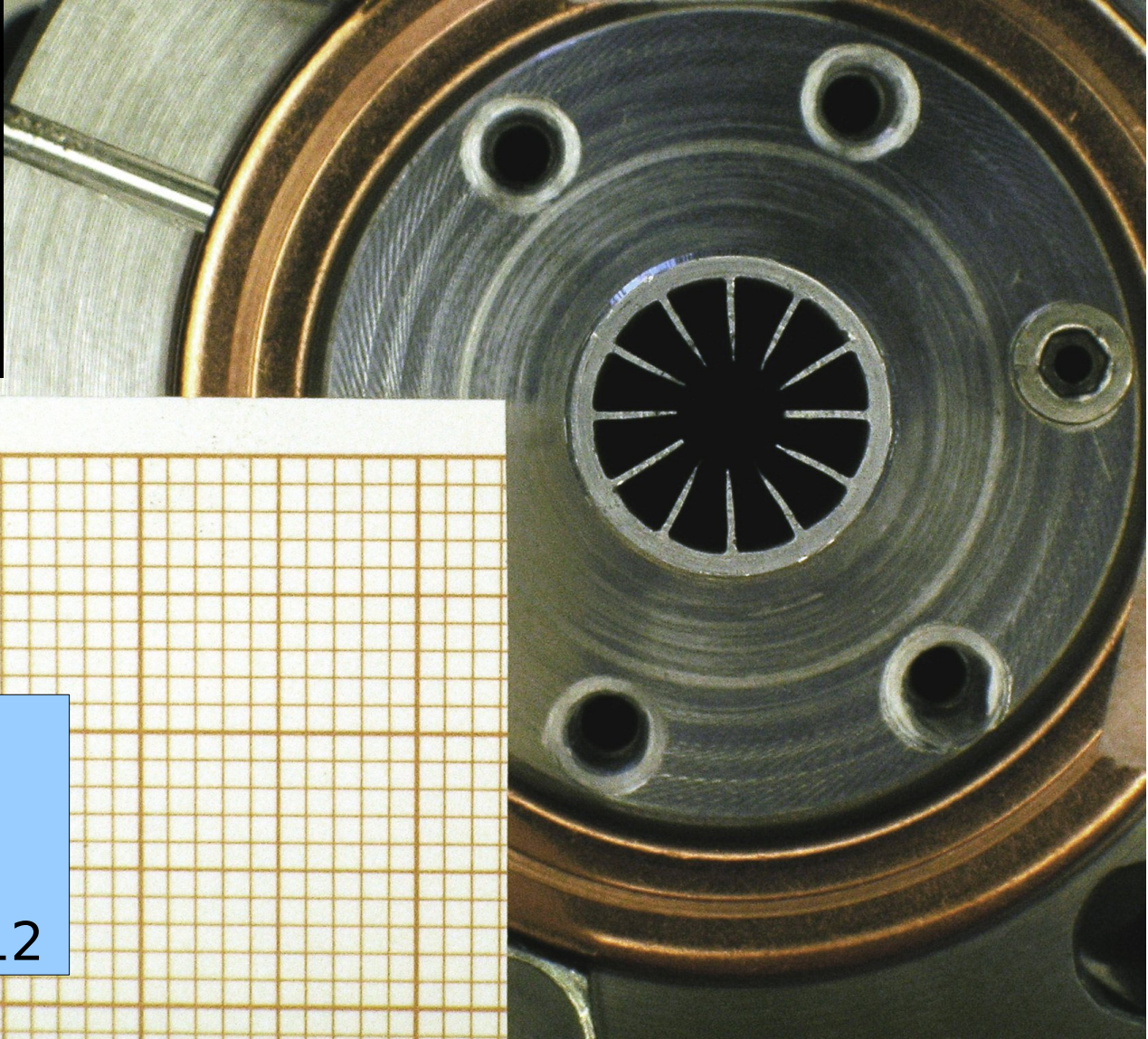
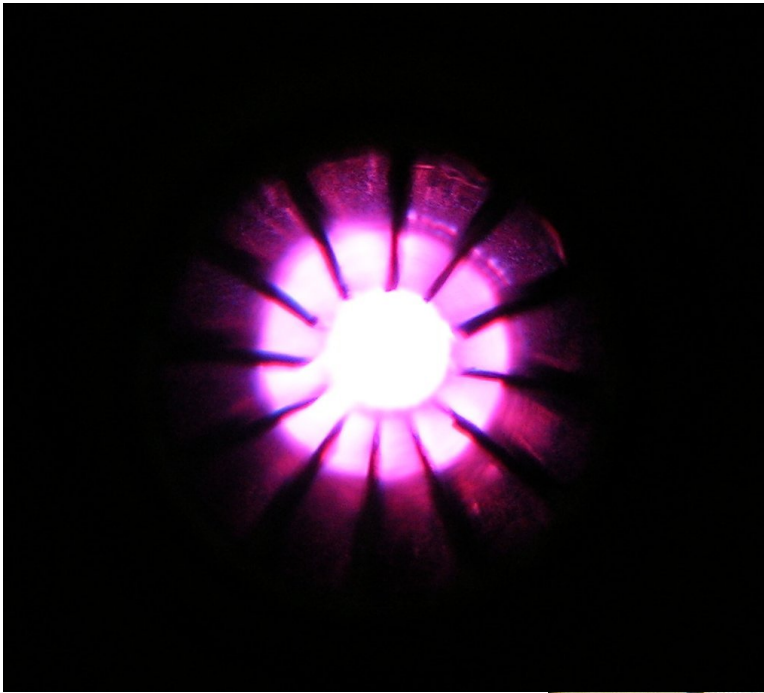

Fins

Thickness: 0.2 mm
Length: 3 mm
Number: 0 - 5 - 10 - 12

24/03/2009

Test stand (ABS2)

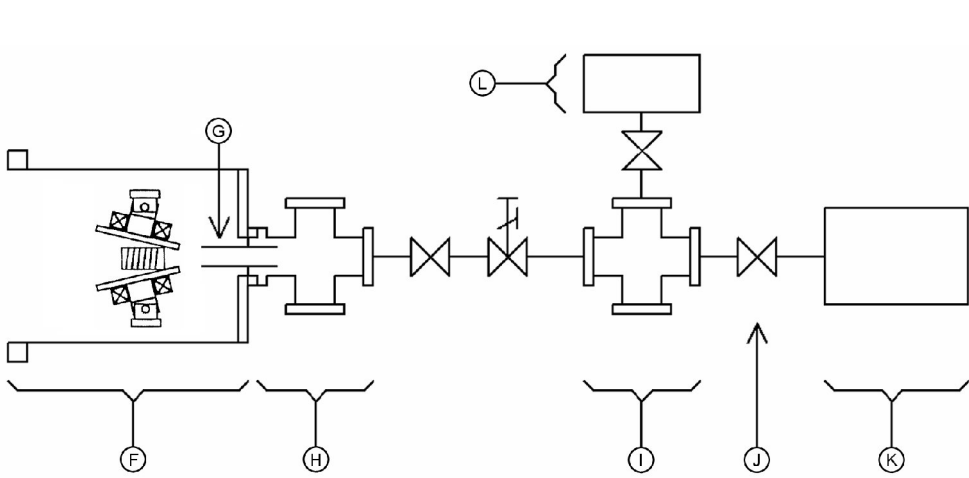
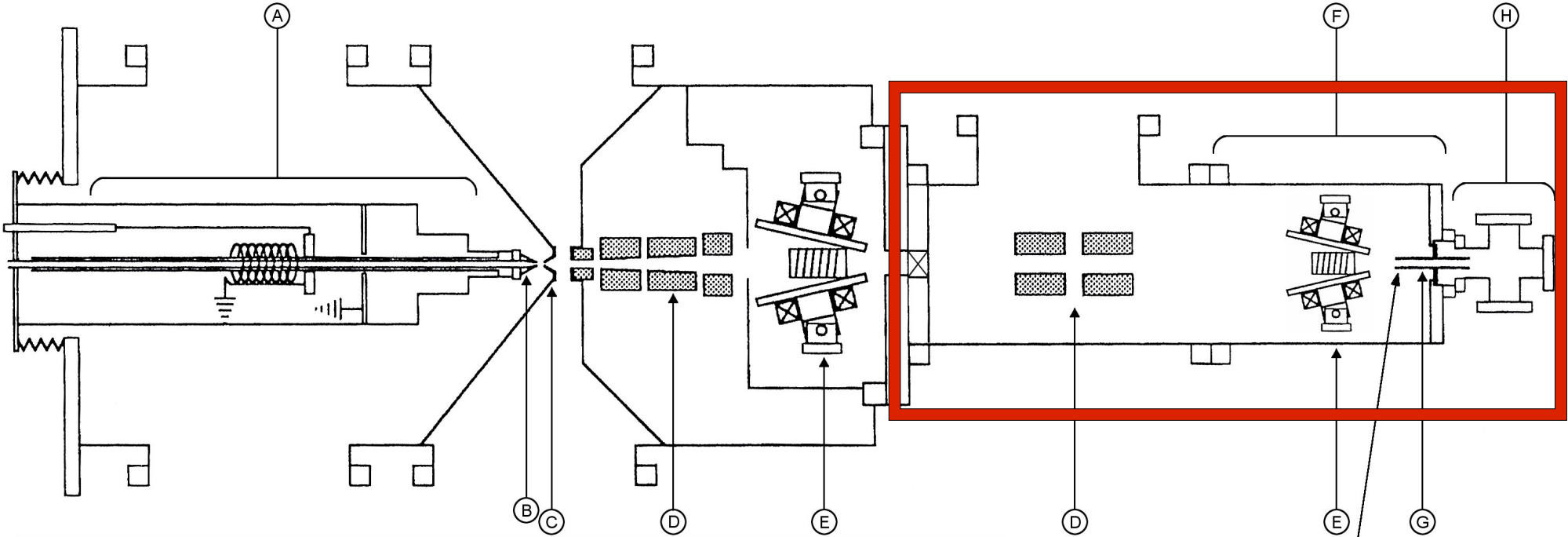

- B) Nozzle
- C) Skimmer
- G) Compression Tube
- H) Compression Volume
- I) Vcal

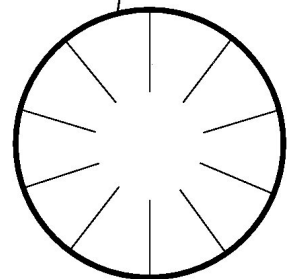

$$I = \frac{2}{K_B T} \cdot P_{CV} C_{inj}$$

Relative conductance (meas + fit)

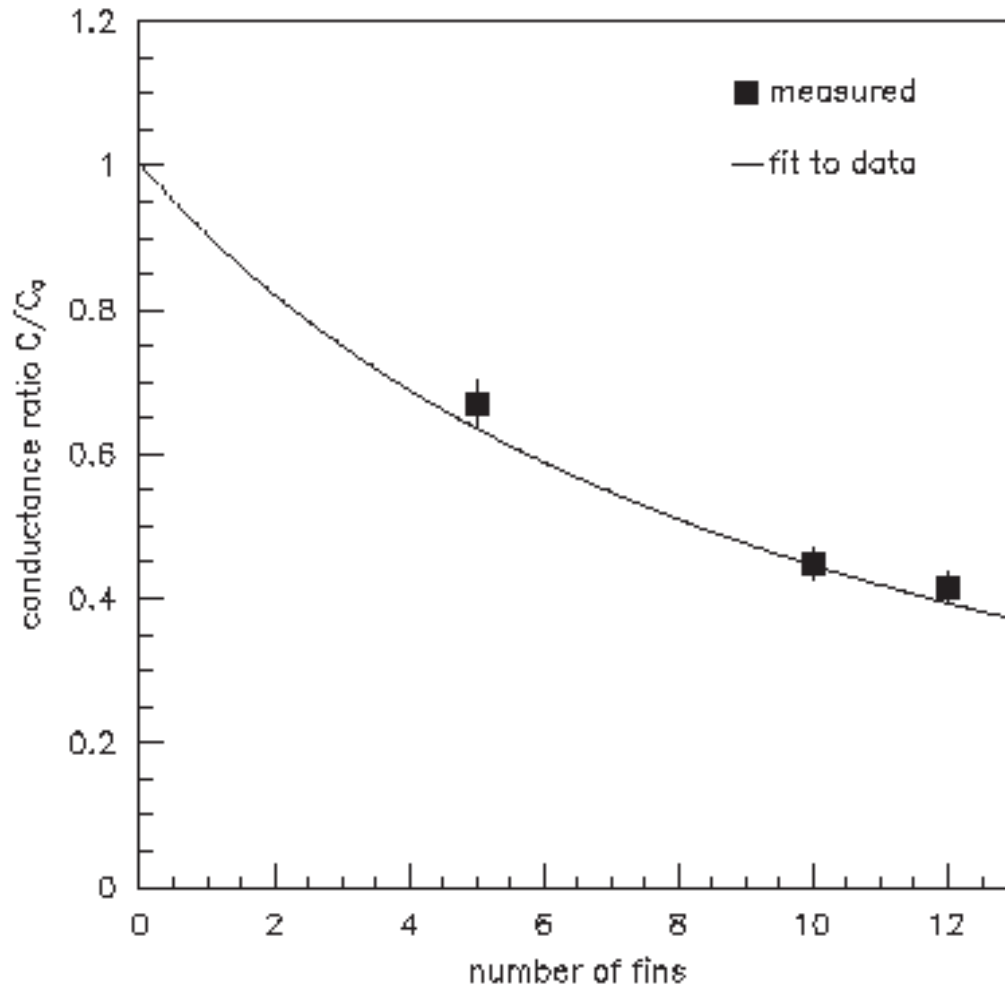

$$C = Q/P_{cv}$$

$$C = \frac{8}{3\sqrt{\pi}} \left(2k_B \frac{T}{M} \right)^{1/2} \left(\frac{A^2}{sL} \right)$$

$$t = \frac{I L}{C_{tot}}$$

CV intensity

$$I = \frac{2}{K_B T} \cdot P_{CV} C_{inj}$$

Pressure (meas)

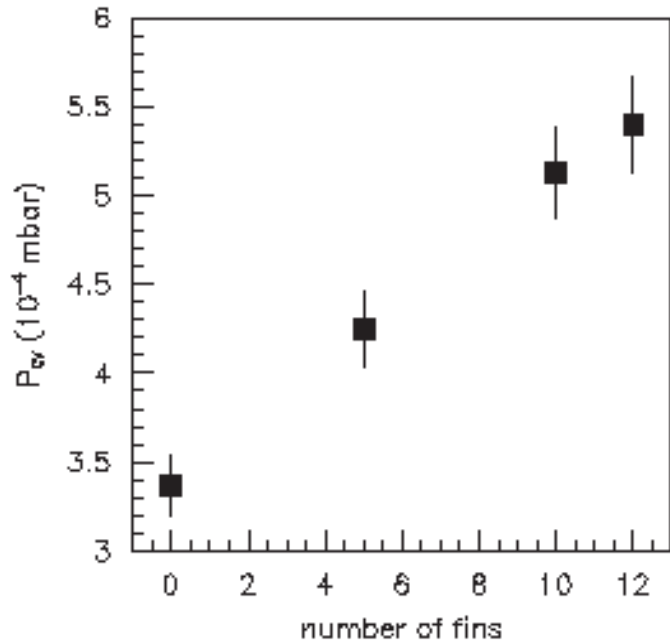

Intensity (calculated)

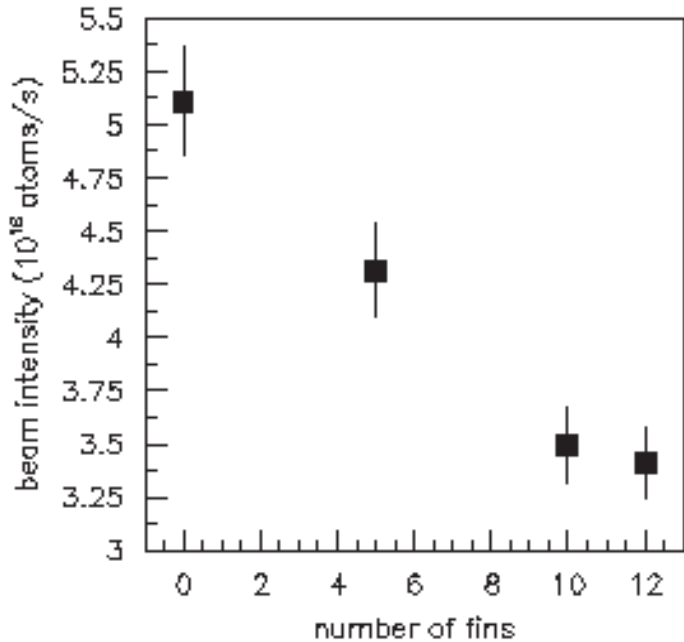

Intensity decrease larger than expected

PAX cell

Relative target thickness for PAX cell

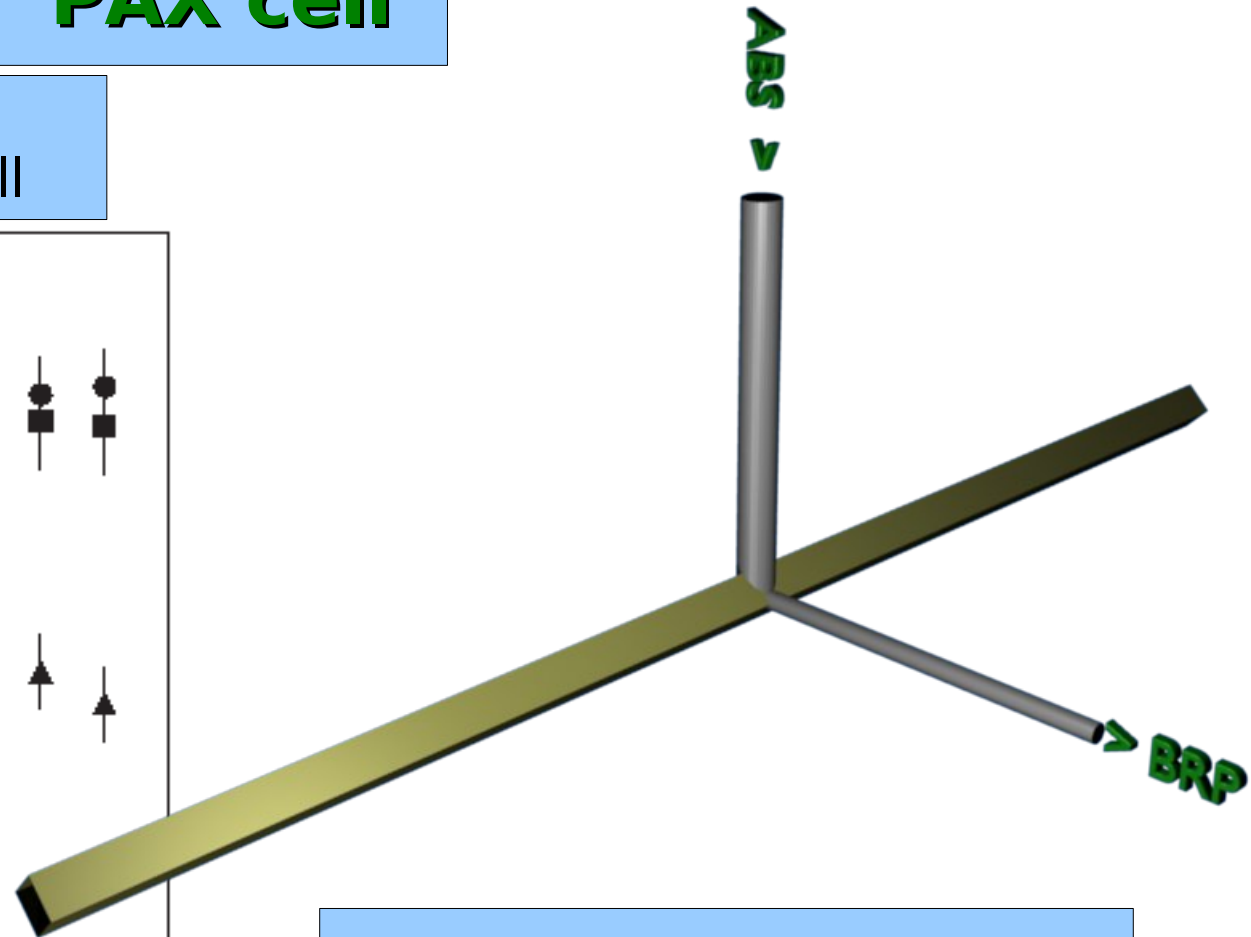
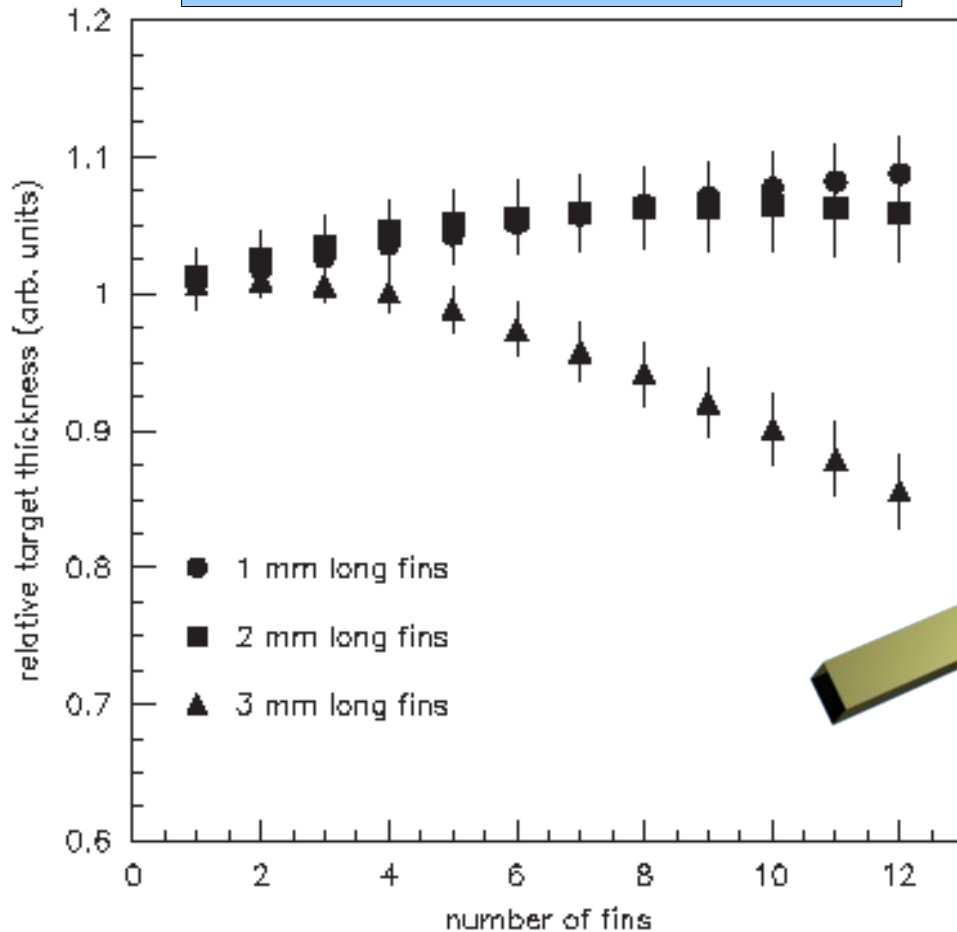

For PAX cell (C_{INJ} 39%)
geometry no useful results
(lower conductance but also
lower beam intensity)

First evidence of azimuthal velocity component of the atomic beam

Intensity drop (I/I_0) is bigger than expected: necessary to consider **azimuthal component** of atoms velocity (new!)

Calculations with surfaces of area 2 - 3 - 4 mm used as **“starting generator surface”**

▼
Match with 2mm
(like nozzle)

z_{SGS} independent for 0-30 mm

Nuclear Instruments and Methods in Physics Research
A 594 (2008) 126-131

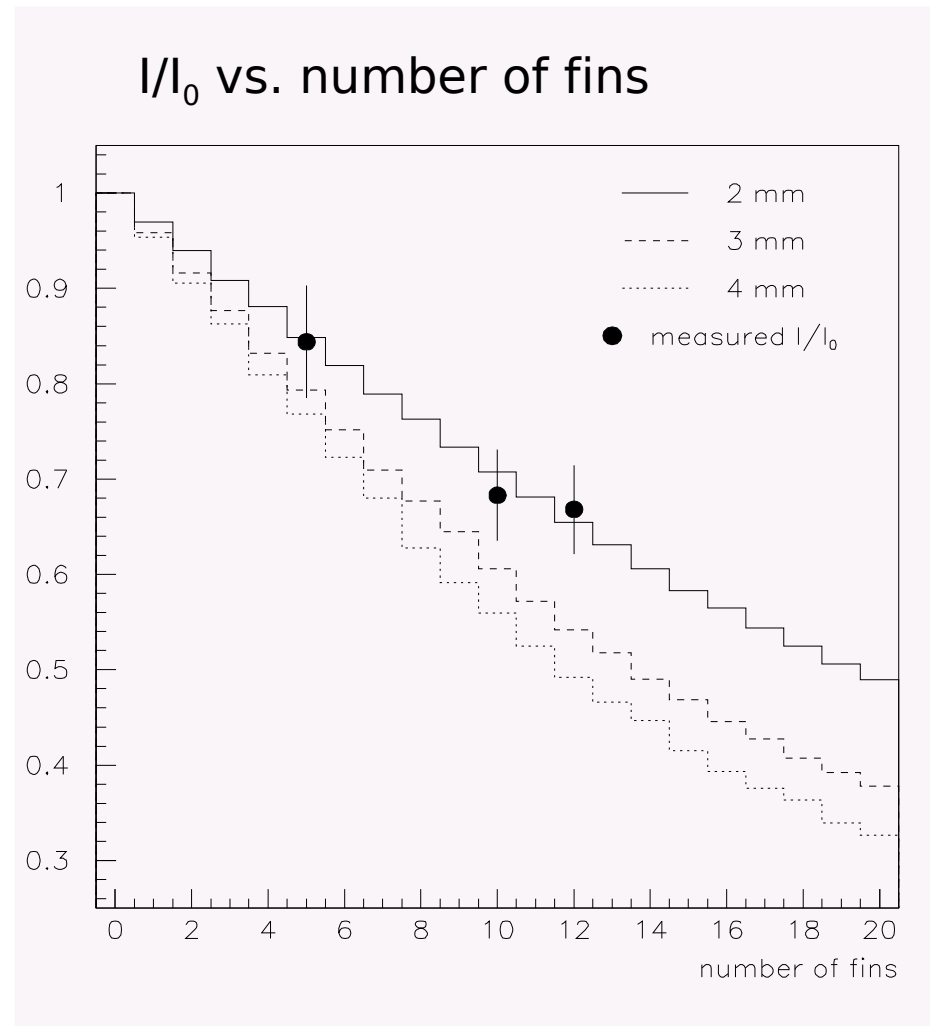

SCAN (sextupole tracking software)

Polarized gas target

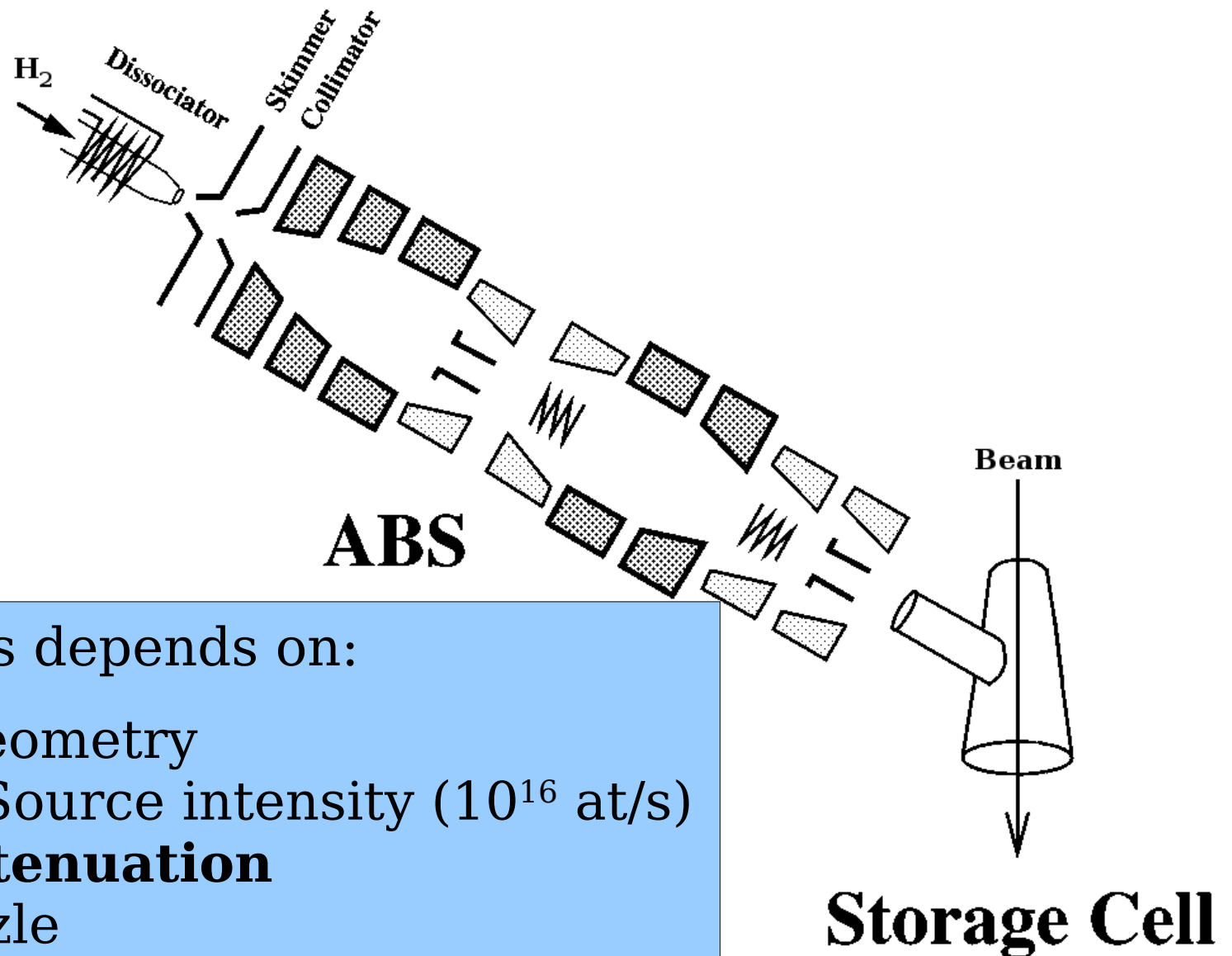

Target thickness depends on:

- Storage cell geometry
- Atomic Beam Source intensity (10^{16} at/s)
 - **Rest Gas Attenuation**
 - Trumpet nozzle

Rest Gas Attenuation measurements on H/D beams

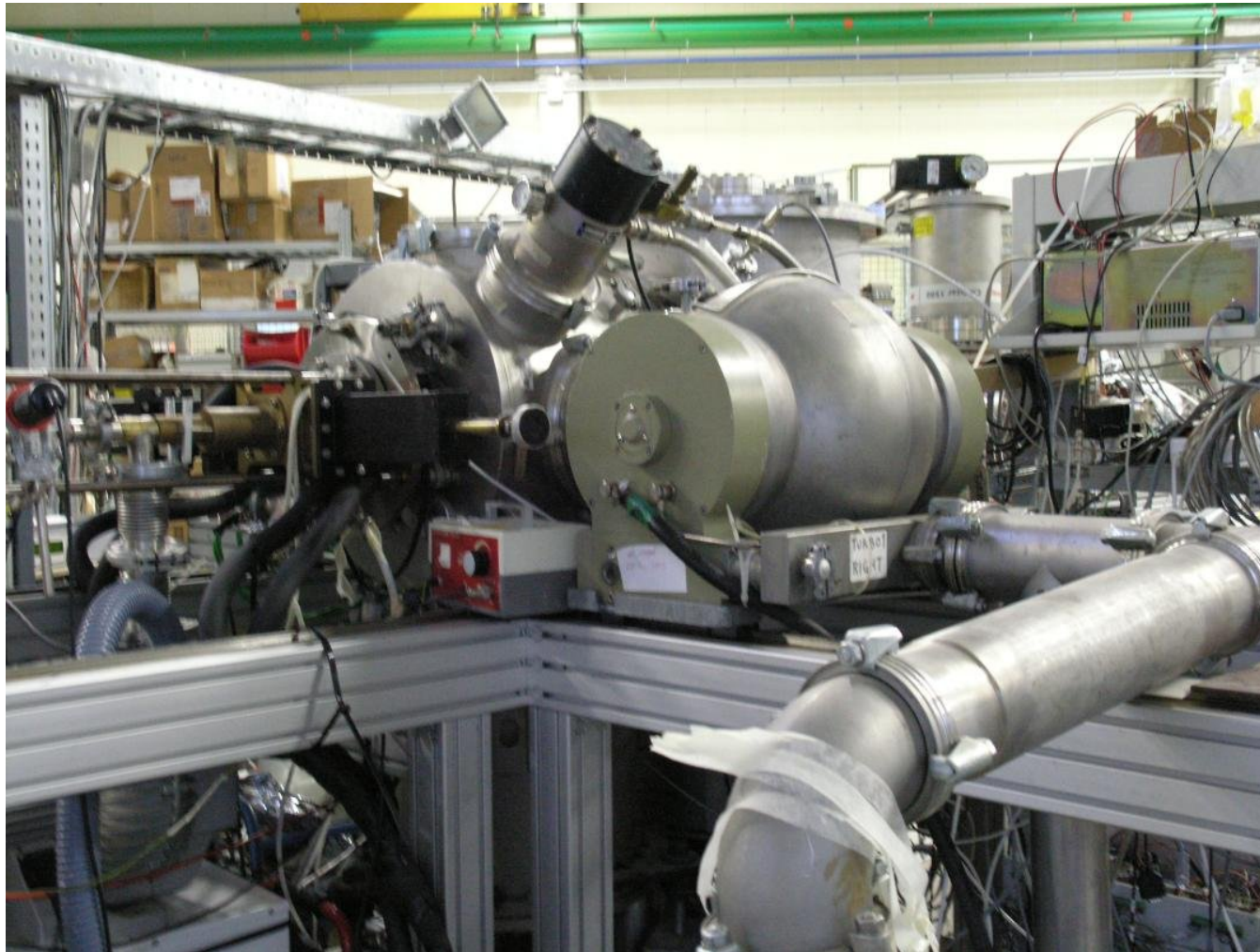

Intensity of world ABS

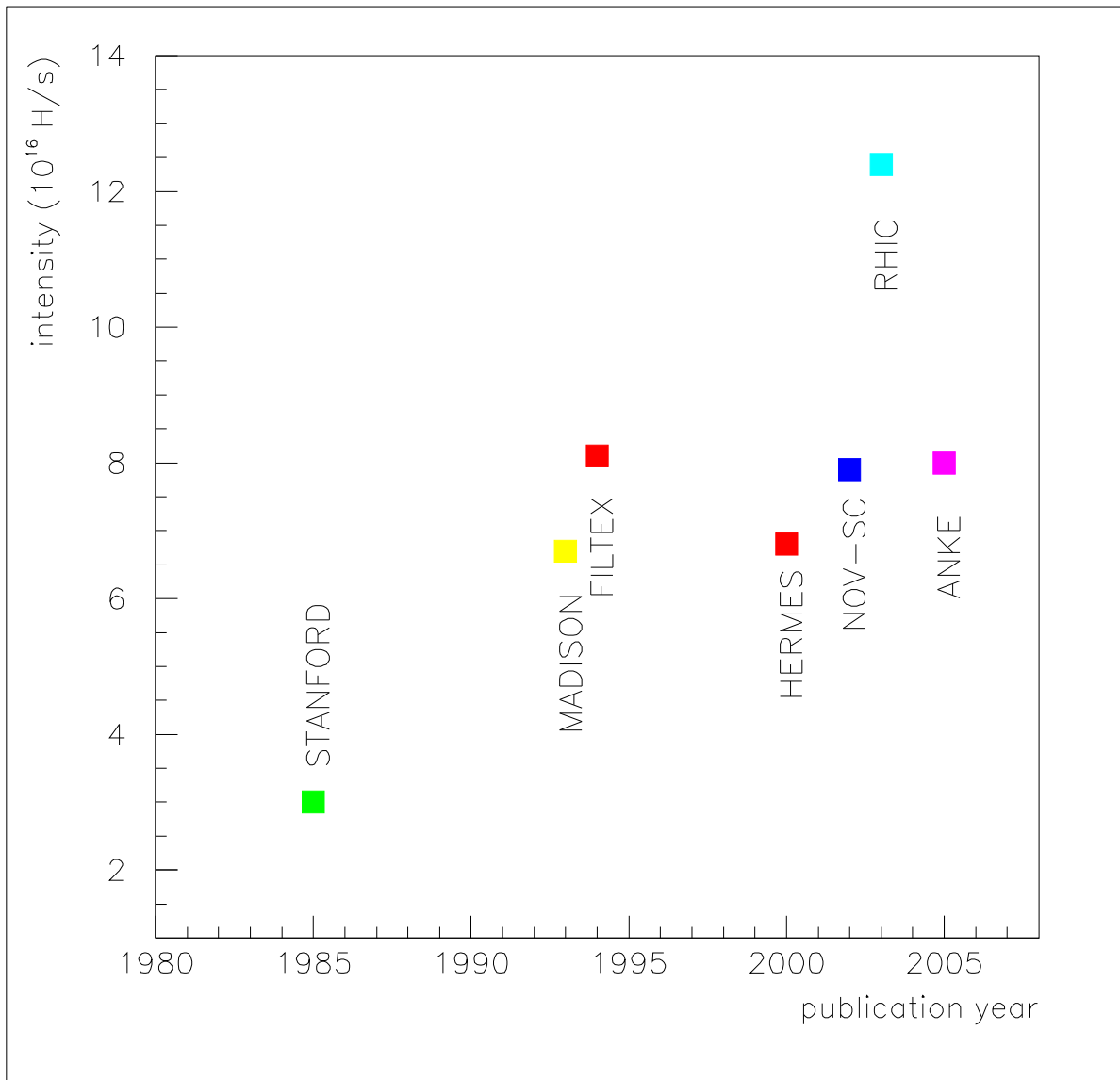

- Intra Beam Scattering
- Rest Gas Attenuation

RHIC still unexplained

ABS beam intensity (how to increase it)

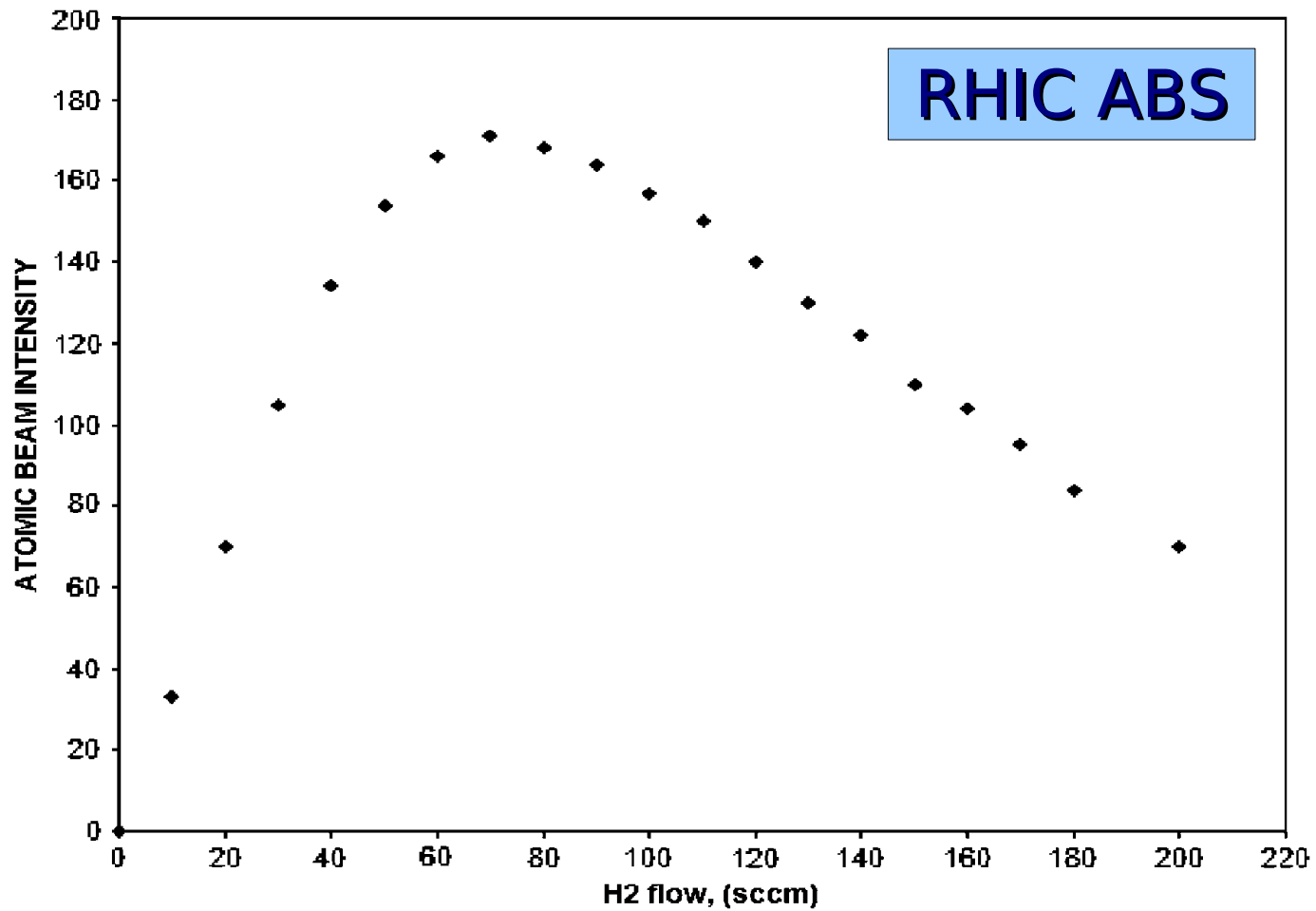

Interaction beam - rest gas

$$I_{OUT} = I_{IN} \cdot \exp[-A n L] = I_{IN} \cdot \exp\left[-\frac{A P L}{k_B T_{RG}}\right]$$

A
attenuation coefficient

●
scattered
molecules ●

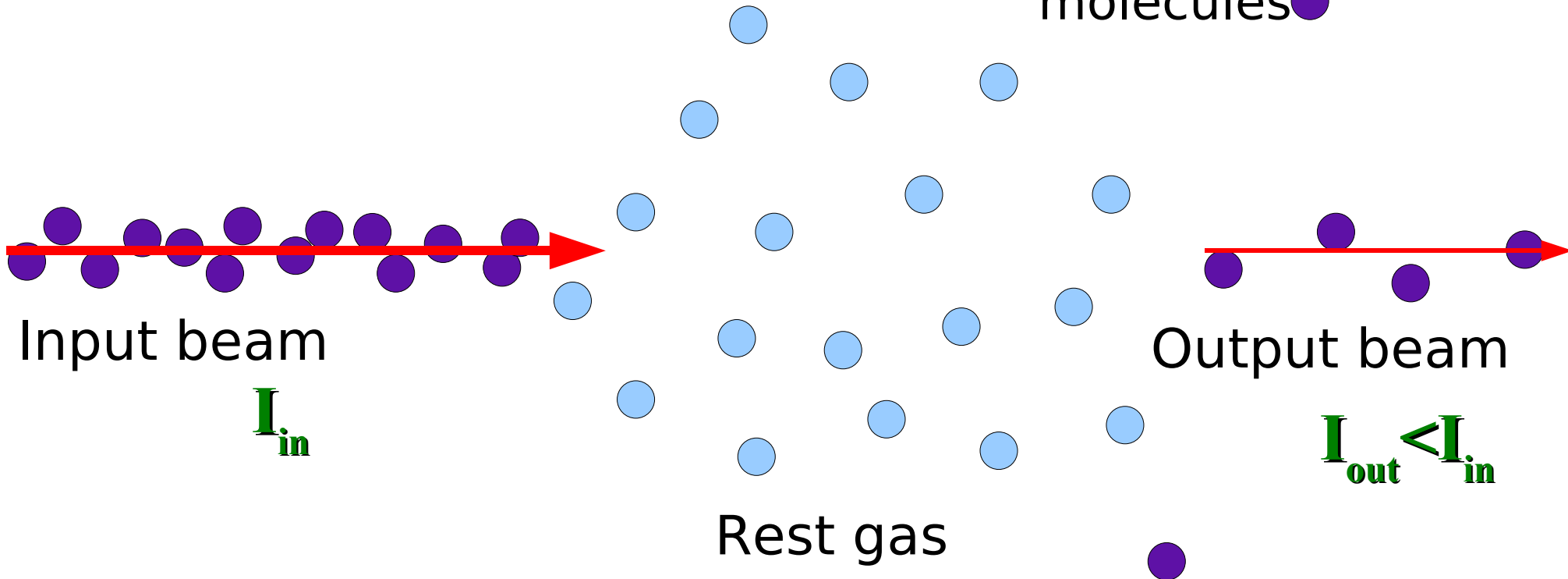

ABS1 layout

125 sccm

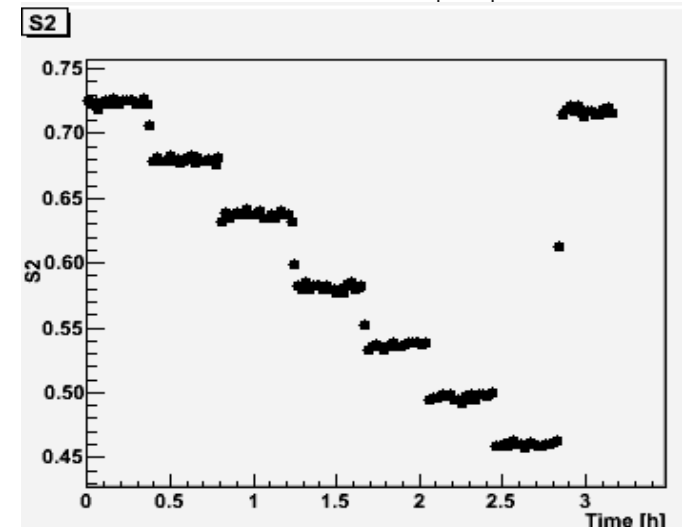
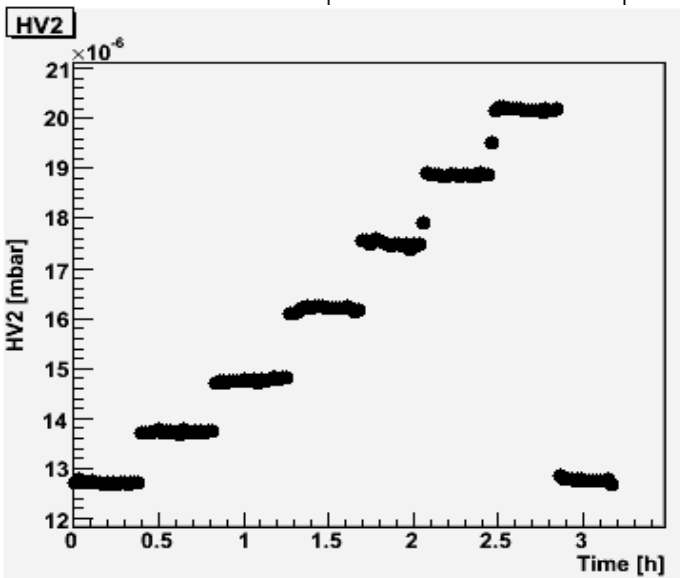
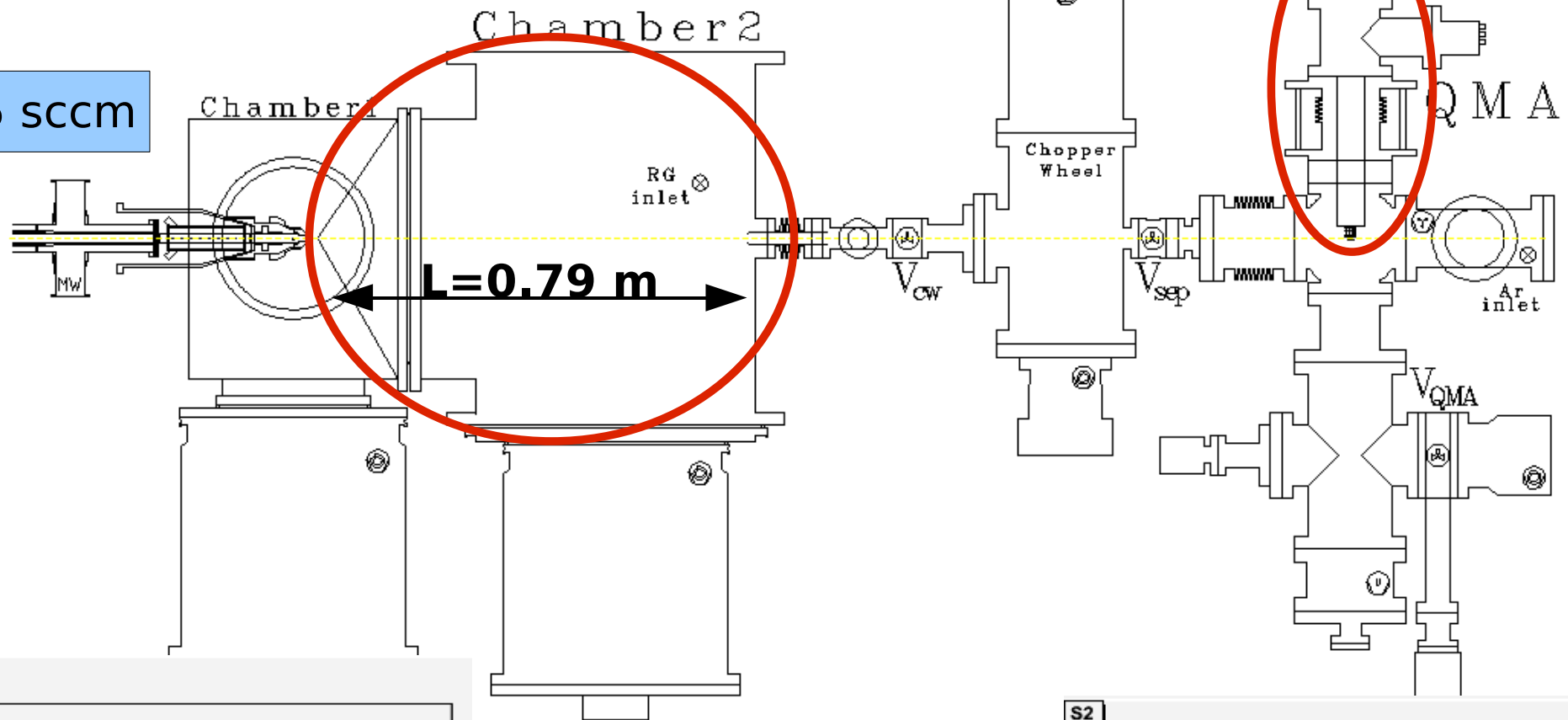

Luca Barion - Esame dottorato

Measurements

Set 1 (mol)
 T_{noz} 55 K

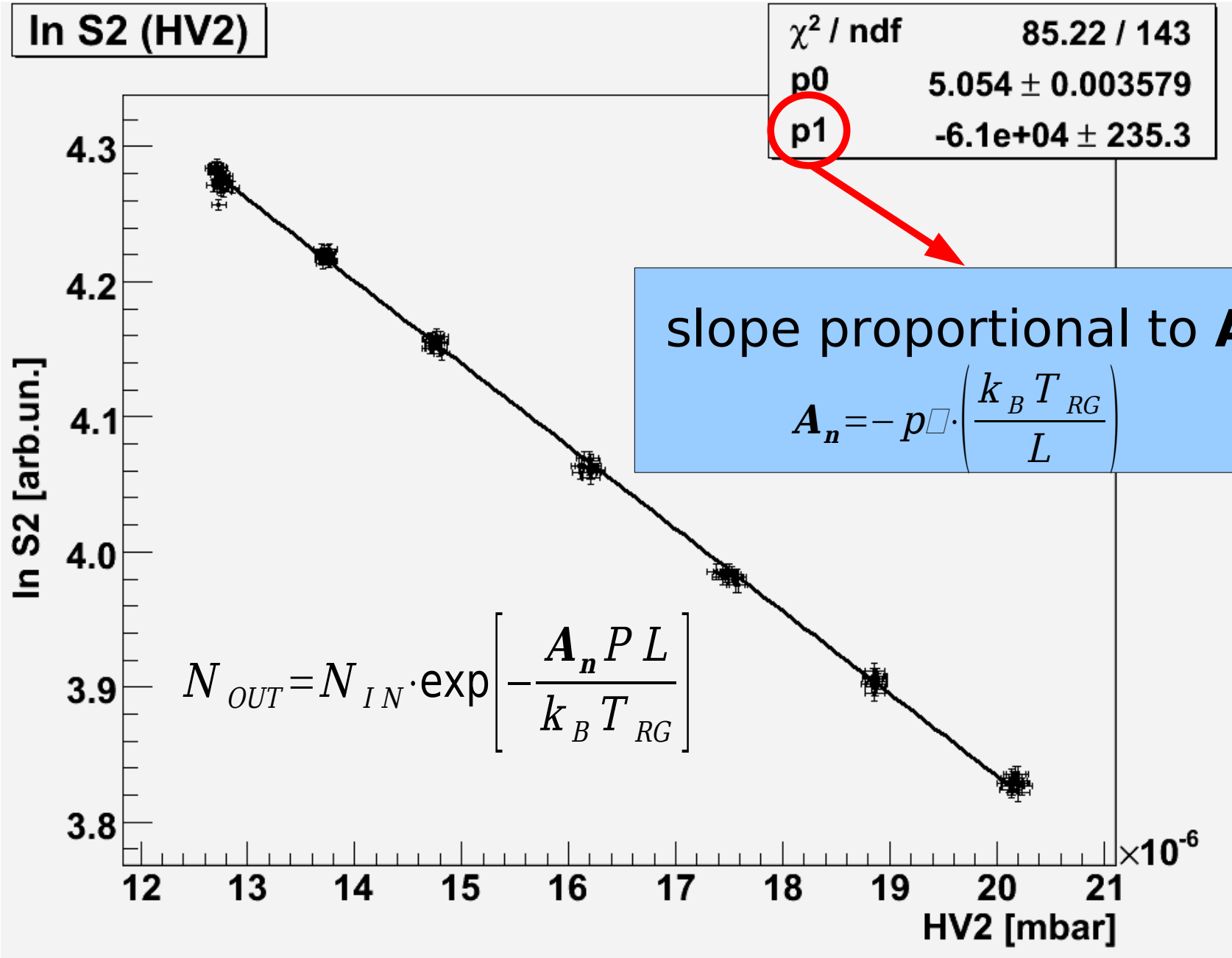

Attenuation coefficient as function of T_{nozzle} (standard in literature)

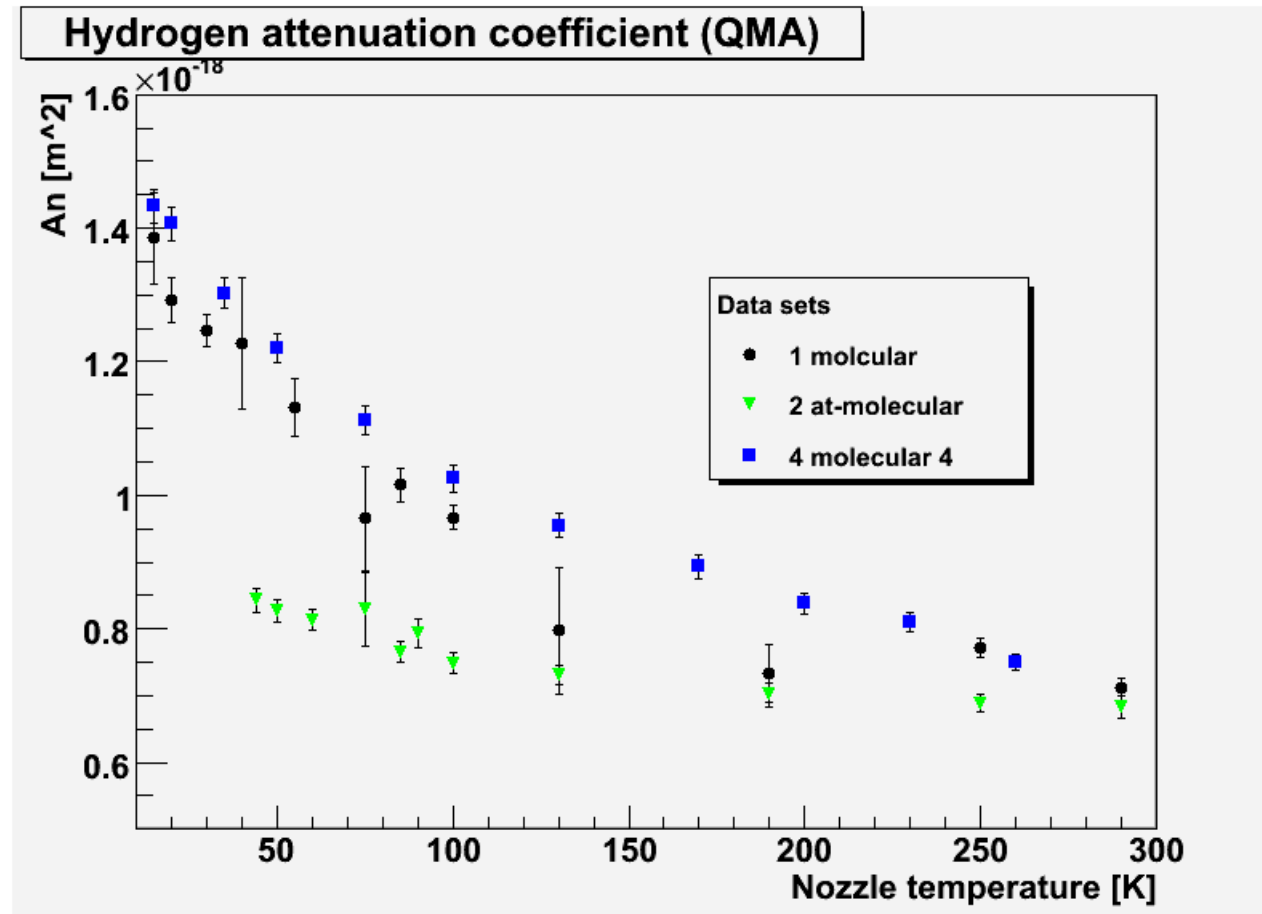

Time Of Flight (TOF) (working principle)

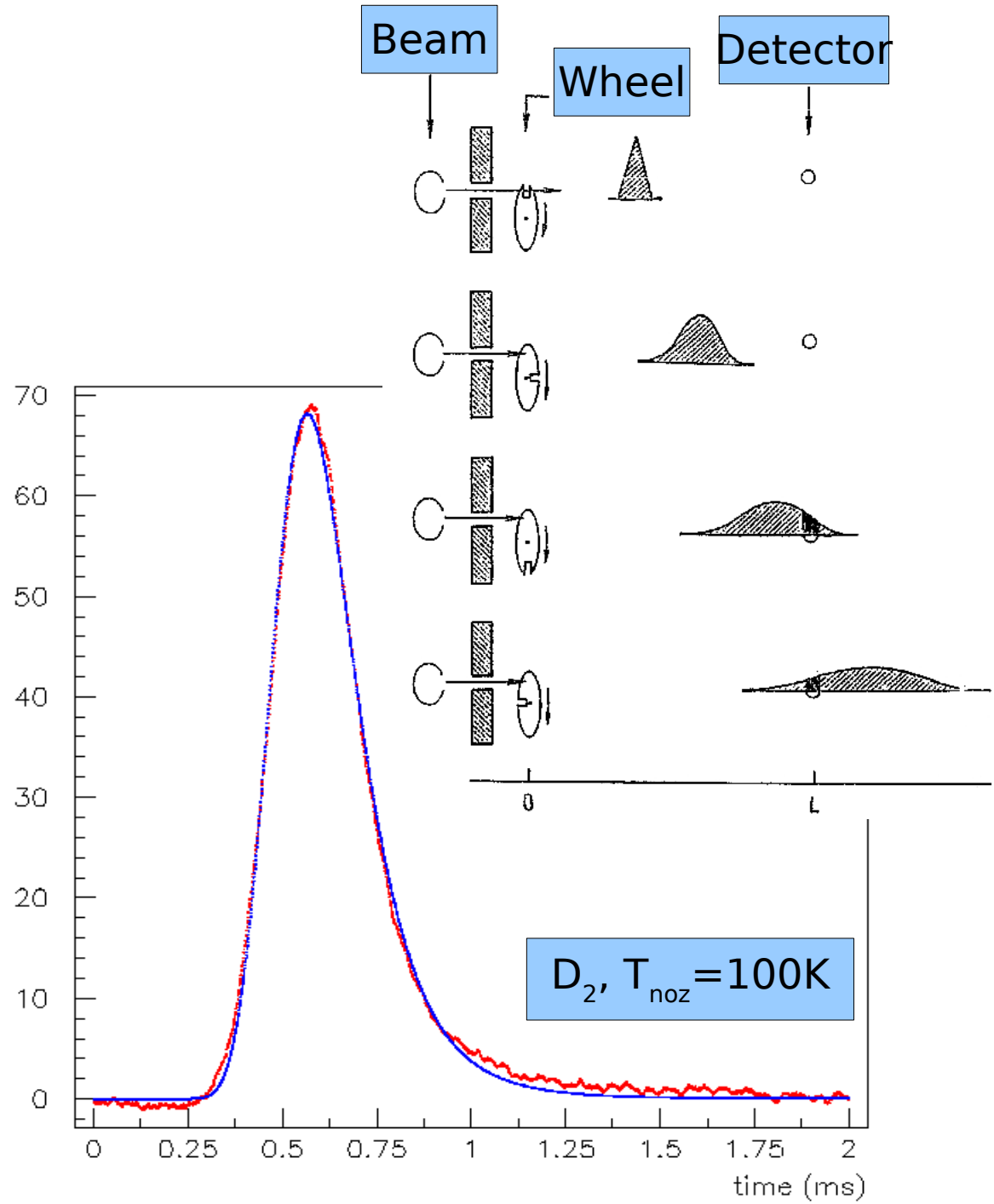
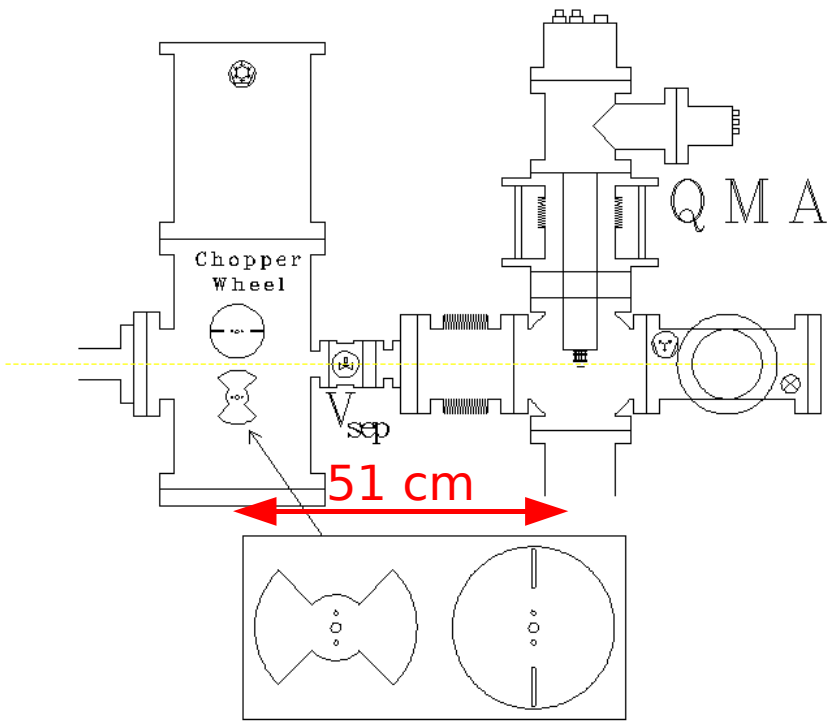

Attenuation coefficient as function of Beam velocity (NEW!) (Molecular Hydrogen beam)

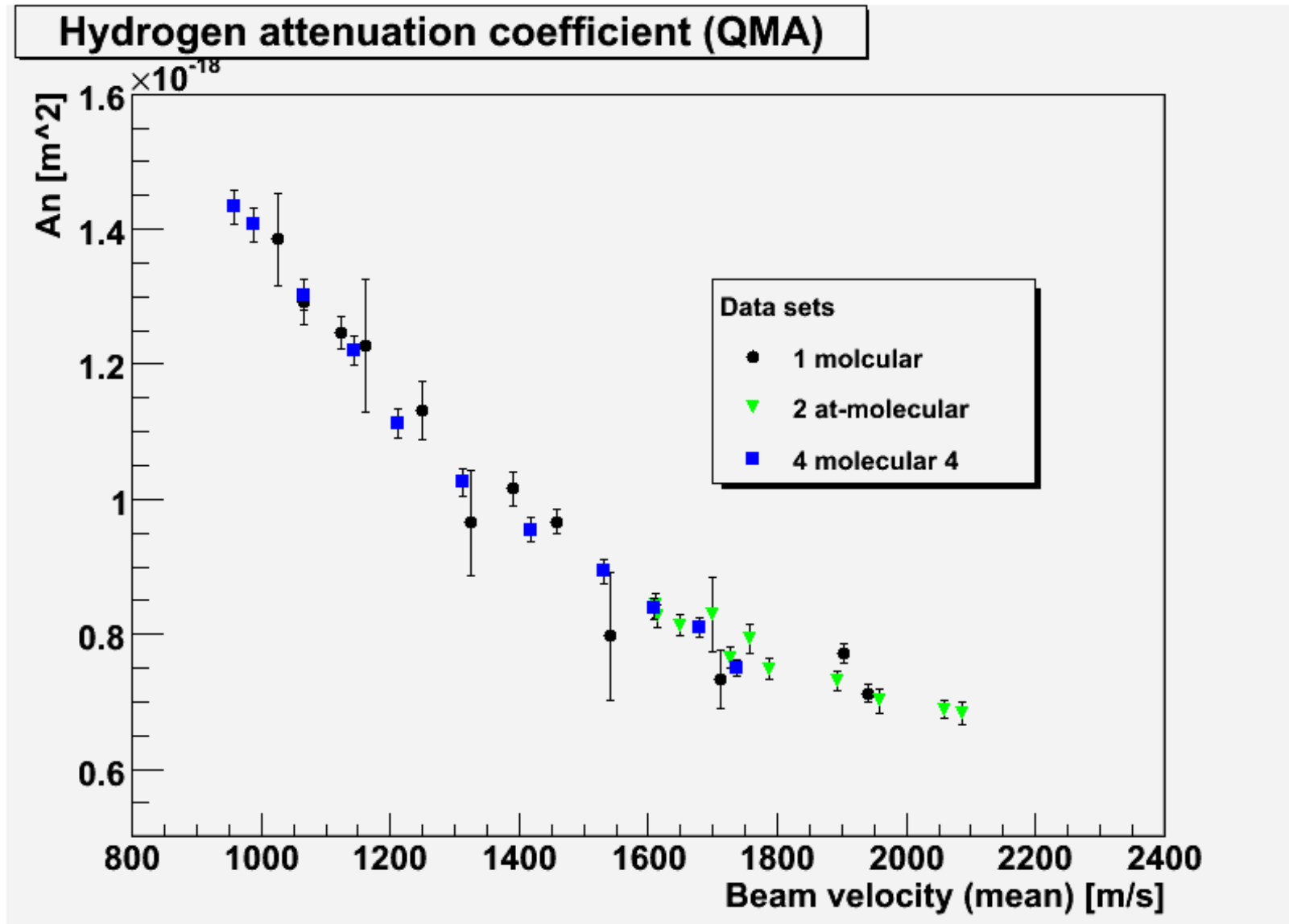

Attenuation coefficient as function of Beam velocity (Molecular Deuterium beam)

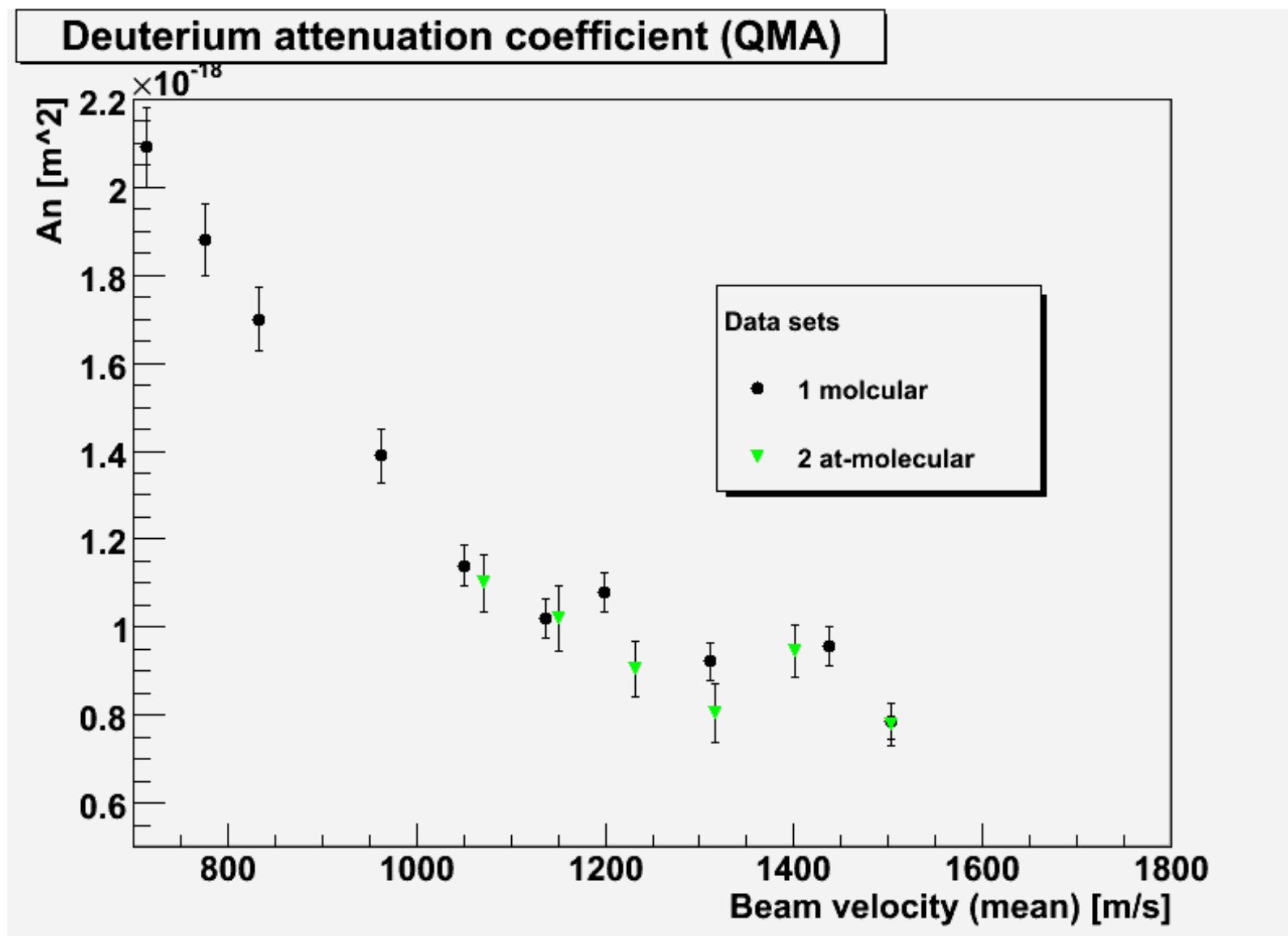

Attenuation coefficient as function of Beam velocity (Atomic Hydrogen and Deuterium)

Hydrogen attenuation coefficient (QMA)

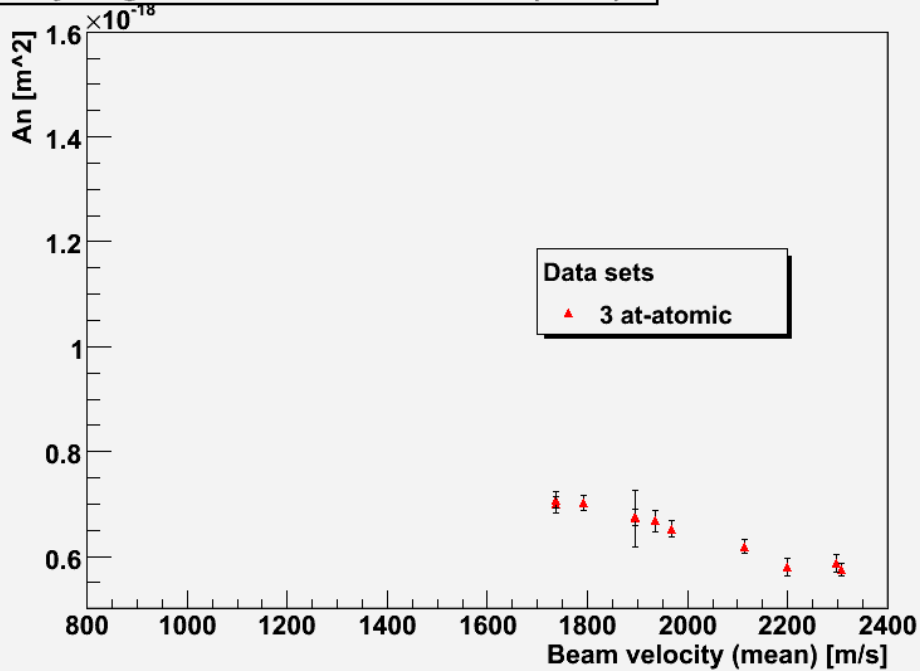

Deuterium attenuation coefficient (QMA)

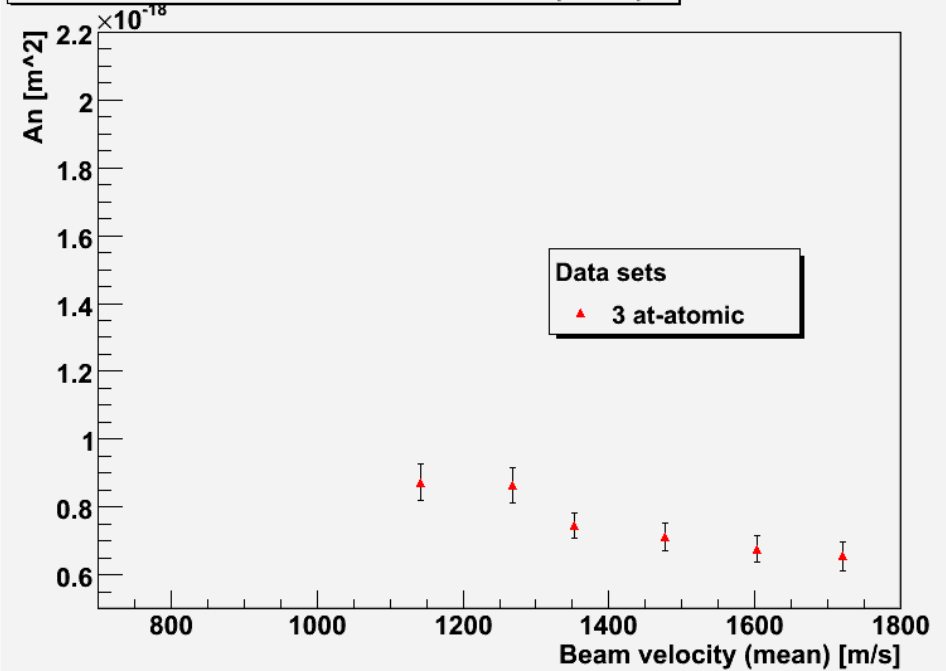

(Publication in preparation)

Atomic beam attenuation in ABS1

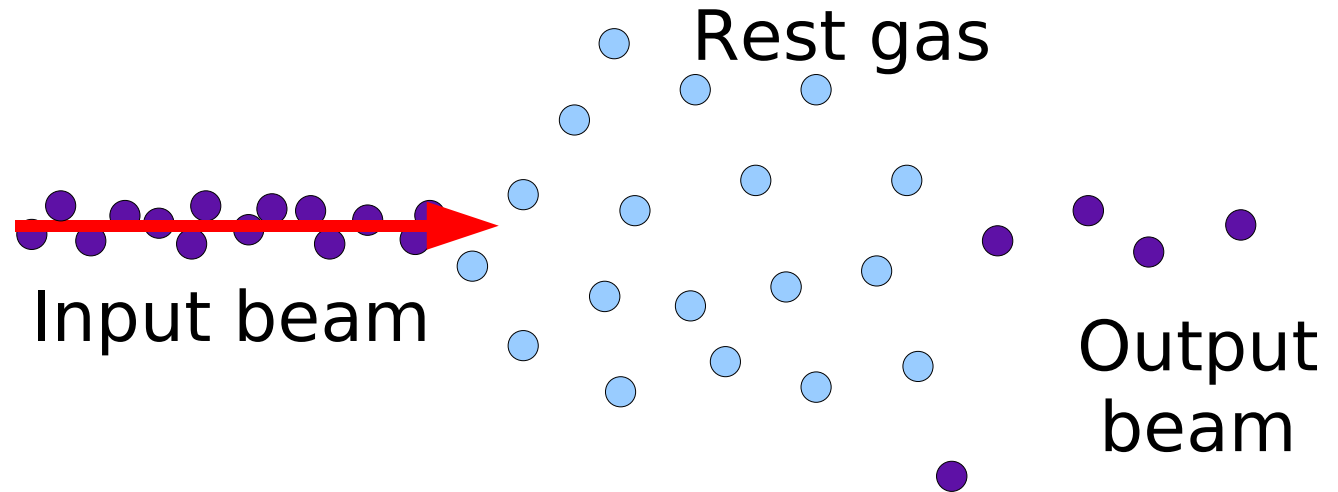

In ABS1 at standard operating conditions
> 45% of atomic beam is lost due to
rest gas attenuation in Chamber 2

Polarized gas target

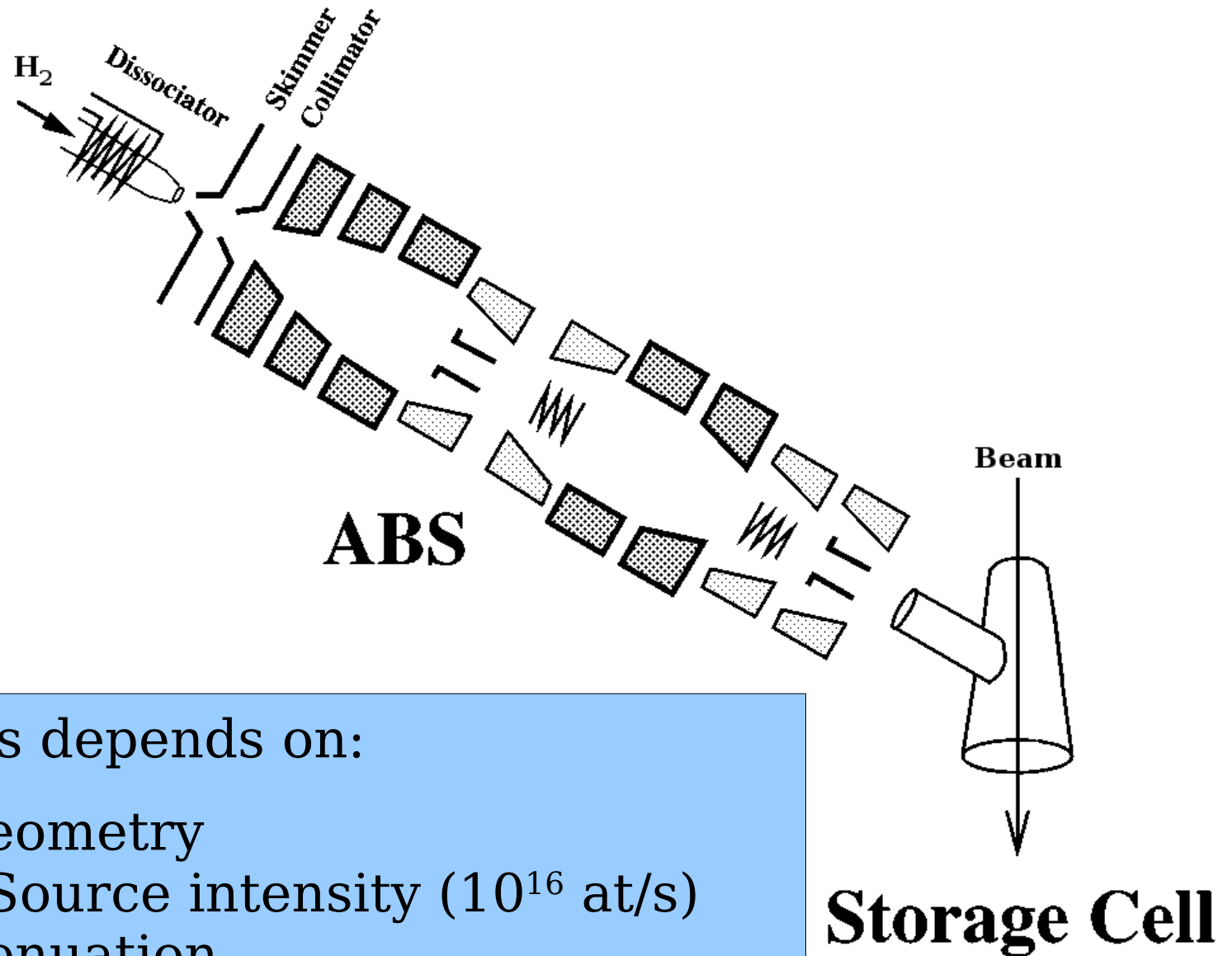

Target thickness depends on:

- Storage cell geometry
- Atomic Beam Source intensity (10^{16} at/s)
 - Rest Gas Attenuation
 - **Trumpet nozzle**

Trumpet nozzle

Possible way to increase beam intensity

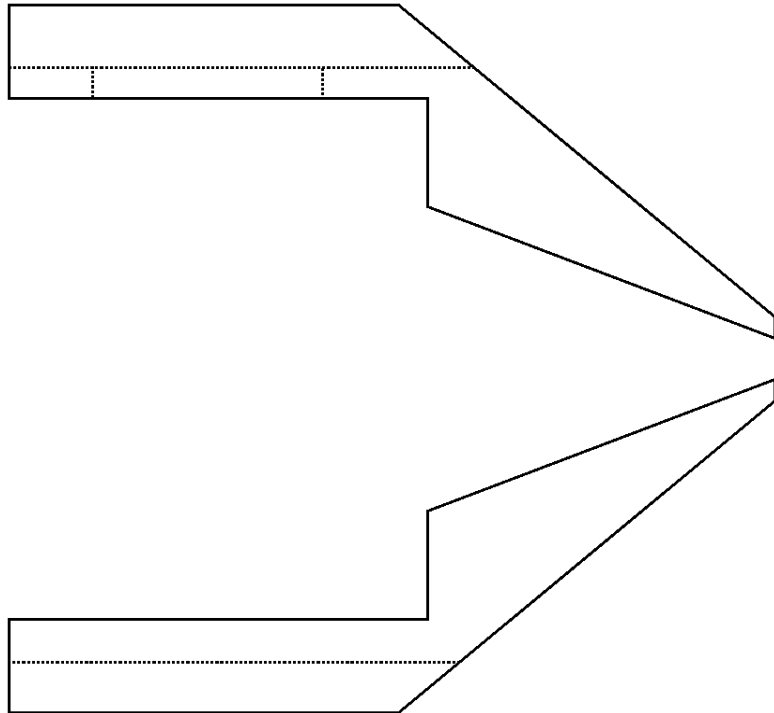

Nozzle #3 (sonic)

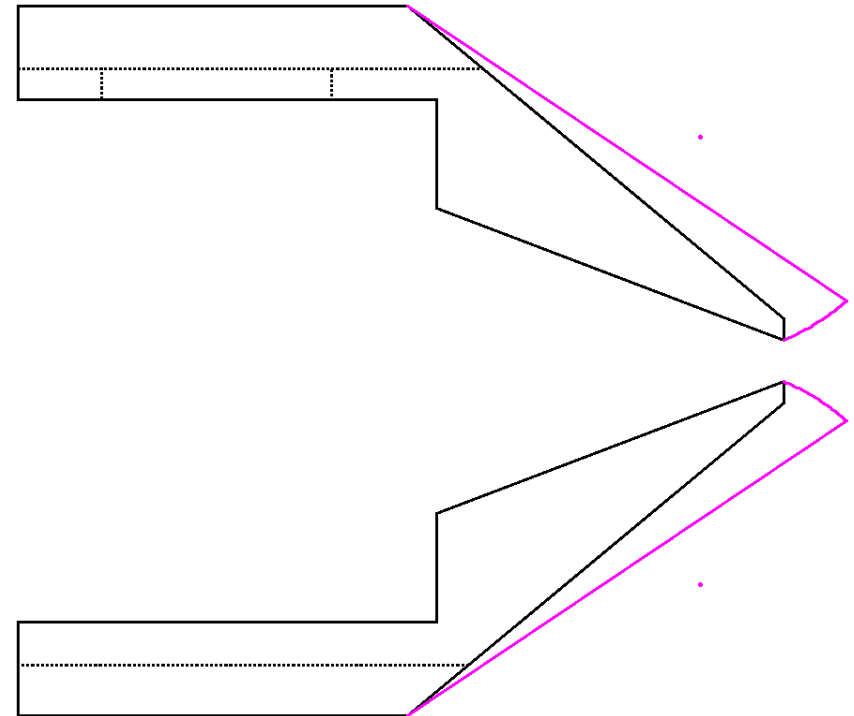

Nozzle #4 (trumpet)

Monte Carlo simulation (ds2g by Bird) => improvement of beam intensity

Montecarlo simulations (molecules)

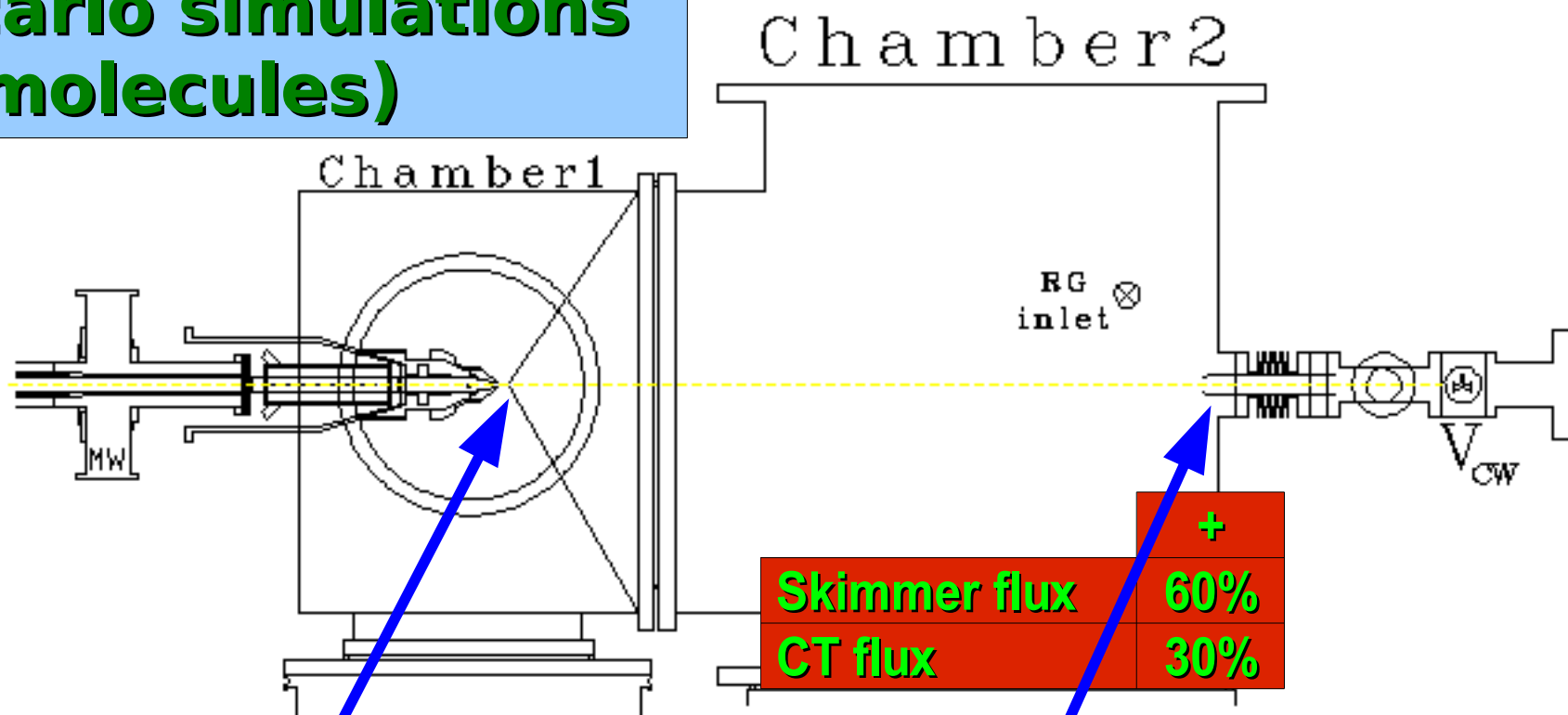

Skimmer flux

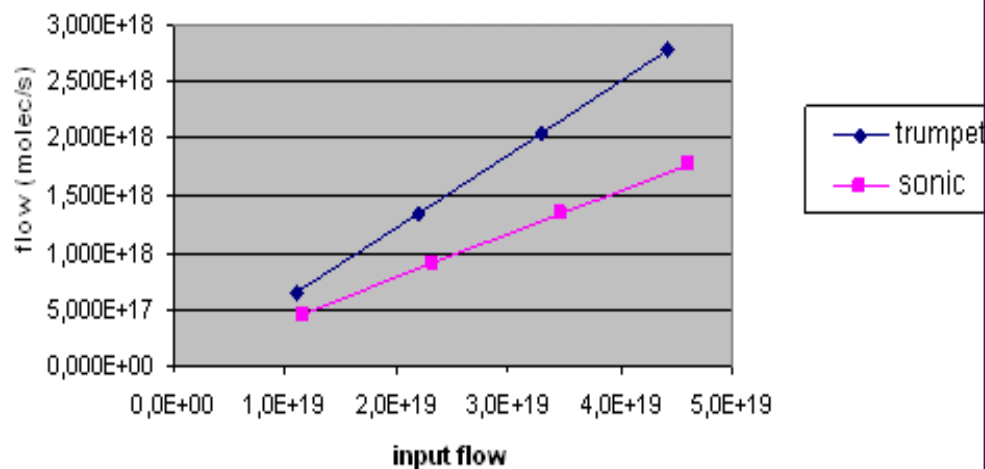

CT flux

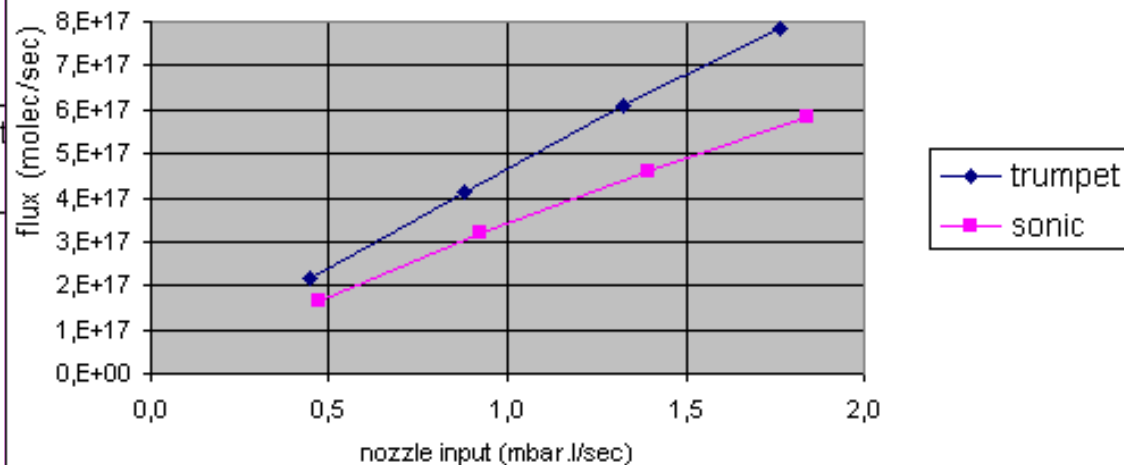

Measured beam intensity through skimmer (Chamber 2 used as Compression Volume)

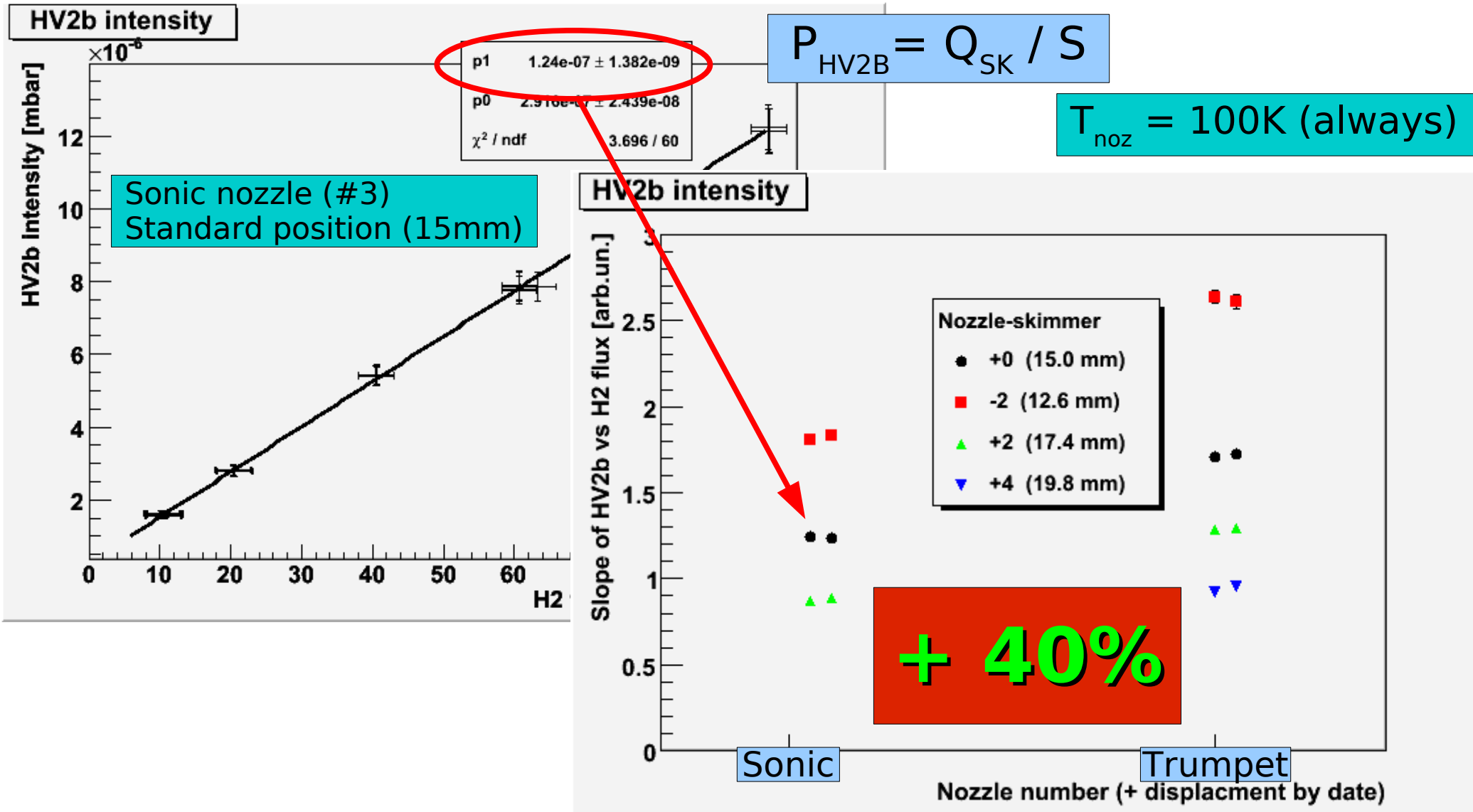

Measured beam intensity in the Compression Volume

Beer's law:

$$I = I_0 \cdot \exp(-A_i n L)$$

$$I_0 = I \cdot \exp\left[\frac{A_i p L}{k_B T}\right]$$

Compression Volume intensity

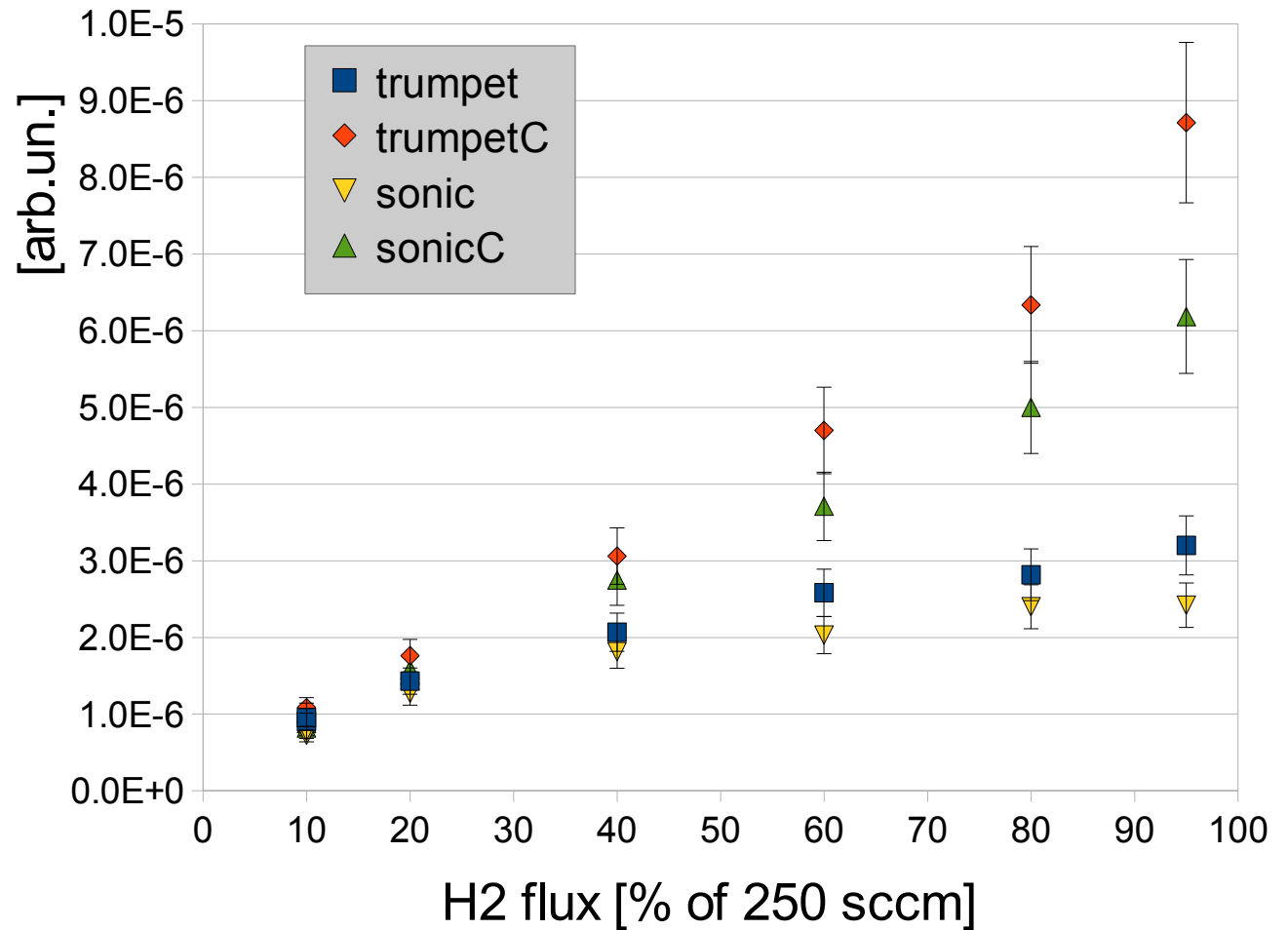

Measured beam intensity in the Compression Volume

$$I = \frac{1}{k_B T} \cdot P_{CV} C_{CT}$$

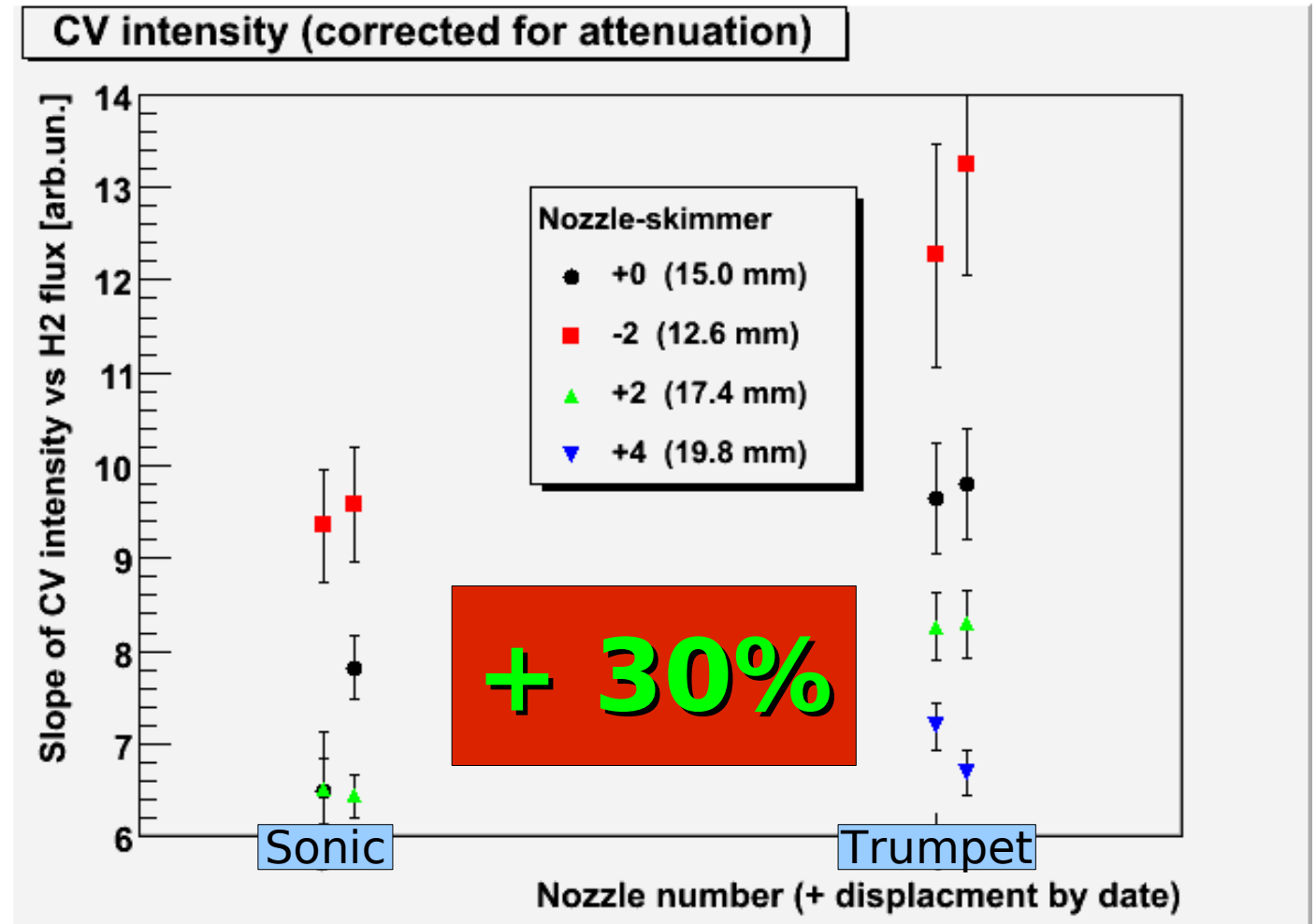

Summary

- **Finned injection tube** (**published**)
 - Not useful for PAX but maybe useful for other geometries
 - Azimuthal velocity component
 - Appropriate Starting surface for our apparatus
- **Rest Gas Attenuation** (**publication in preparation**)
 - Attenuation coefficients useful for calculations (independent from experimental setup)
- **Trumpet nozzle** (**publication in preparation**)
 - Simulations and measurements foresee beam intensity increase